

Panasonic®

使用說明書

電風扇 (30 cm 起居室電風扇)

Operating Instructions

Electric Fan (30 cm Living Fan)

型號 / Model No.

F-30SMH

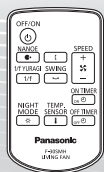
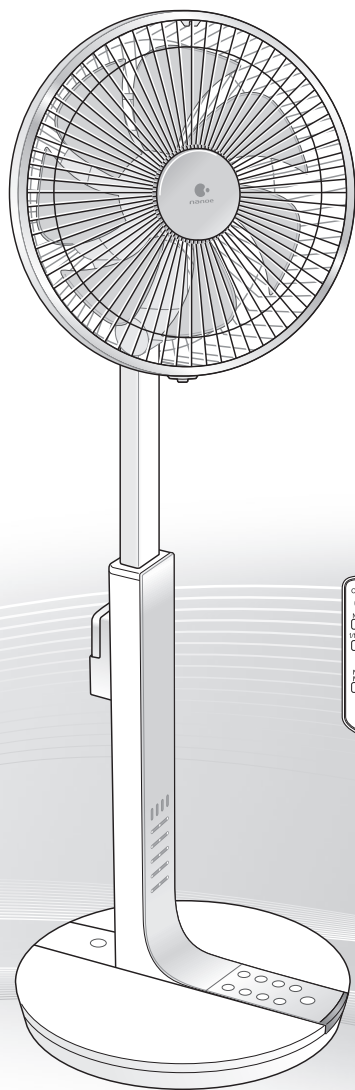

非常感謝你購買此 Panasonic 產品。

使用本產品前，請詳細閱讀本說明書，並保留作日後參考之用。

本產品只可在室內使用

目錄

安全注意事項	2-3
組裝方法	6-9
各部件名稱	10-11
使用方法	12-21
在必要時	22-23
• 保養	
• 如何更換電池	
• 排解疑難	
規格	封底

Thank you very much for purchasing this Panasonic product.

Before operating this product, please read the instructions carefully, and save this manual for future use.

This product is for indoor use only.

Contents

Safety precautions	4-5
How to assemble	6-9
Name of parts	10-11
How to use	12-21
When necessary	22-23
• Cleaning	
• How to replace the battery	
• Troubleshooting	
Specifications	Back cover

安全注意事項

請務必遵守這些指示

為避免引致使用者受傷或財物損壞的可能性，請務必遵守下列注意事項。

• 以下標誌是根據錯誤使用所產生的危險或受傷程度而分類。

	警告	表示如不遵守該指示，可能造成死亡或嚴重受傷。
---	-----------	------------------------

	注意	表示如不遵守該指示，可能造成人身傷害或物品損壞。
---	-----------	--------------------------

• 以下標誌為需要遵守的指示種類。(下列標誌為例子。)

	此標誌表示為禁止事項。		此標誌表示為強制事項。
---	-------------	---	-------------

	此標誌表示為必須小心進行的事項。
---	------------------

	警告
---	-----------

	只應使用隨附的 AC 配接器。 不遵守指示可導致觸電、火災或故障。
---	---

	切勿擅自拆散、修理或改造本產品。 可能著火或運行異常，引致觸電、火災或受傷。 • 本產品故障時，請聯絡經銷商修理。
---	--

	請勿使用超過額定功率的電插座或配線器材。不要將本產品連接至額定電壓及額定頻率以外的電源。 如使用電源延長線等超過額定功率，可能引致發熱，造成火災。
---	---

	出現故障時，立即停止使用本產品，並拔除 AC 配接器。 可能引致發熱，造成觸電或火災。 [故障 / 失靈例子] • 雖然已接駁電源並開機，但電風扇沒有運行。 • 運行時發出異常聲音。 • 移動電源線時停止運行。 • 扇葉不規則地轉動，或轉得很慢。 • 發出焦味。 • 馬達裝置、AC 配接器或電線異常地熱。 請立即聯絡經銷商進行保養 / 維修。
---	--

	除非扇葉及保護網已經正確安裝，否則不要開啟本產品的電源。 此舉可能引致受傷。
---	--

	裝嵌或儲存時，除非扇葉及保護網已經正確安裝，否則不要按高度調整鈕。 馬達裝置及升降桿可能會瞬間鬆脫，並導致身體受傷。
---	--

	不要令電線或 AC 配接器的插頭受損。 (切勿裁剪或改造。切勿強行折曲、扭曲或拉扯。切勿放在發熱器具附近或負重。切勿捆成一札。) 使用損壞的電源線或插頭，可能引致短路等，並造成觸電或火災。 • 請聯絡經銷商維修電源線或插頭。
---	--

	如果電源線已損壞，必須找製造商、服務代理商或合資格人士更換，以免發生危險。
---	--

	確保 AC 配接器的電源插頭已經完全插入插座內。 如插頭鬆脫未插好，可能會引致觸電或插頭過熱而造成火災。 • 請勿使用已損壞的插頭或鬆脫的插座。
---	---

	手濕時不要連接或拔除 AC 配接器。 此舉可能引致觸電。
---	--

	不要將本產品放置在 AC 配接器的電線上。 此舉可能令電源線損壞，引致短路並造成觸電或火災。
--	--

	使用本產品時不要把機身連接插頭推向牆壁等的地方。 此舉可能令電源線損壞，引致短路並造成觸電或火災。
---	---

	請勿把本產品浸於水中或沾水。 可能引致短路並造成觸電或火災。
---	--

	請勿把本產品放置在發熱電器旁邊。 塑膠部件可能溶化而起火。
---	---

	移動或收起本產品時請勿拉扯電源線。 此舉可能令電源線損壞，引致短路並造成觸電或火災。
---	--

	請勿在風扇運行時拉緊電源線。 此舉可能令電源線損壞，引致短路並造成觸電或火災。
---	---

	請勿拿著手柄擺動產品。 此舉可能引致受傷或產品受損。
---	--------------------------------------

	不要將固定針或金屬等的異物放入 nanoe™ (納米離子) 出風口內。 這些物件會接觸到裡面的零件，並導致觸電或身體受傷。
---	---

	裝嵌、清潔和儲存本產品時，確保拔除 AC 配接器。 本產品可能會無預期地開始運作，引致受傷或觸電。
---	---

! 定期抹去 AC 配接器電源插頭上的塵埃。

如電源插頭上積聚了灰塵，潮濕的空氣等可能引致絕緣不良而起火。

- 拔除 AC 配接器，然後用乾布擦拭。
- 長期不使用時，拔除 AC 配接器。

! 把鋰電池放在幼童觸及不到的地方。

幼童可能意外吞下。如出現此情況，請立即就醫。

! 注意

⊘ 切勿在以下場所使用本產品：

- 接近易燃氣體或火源如爐具等場所。
- 暴露於雨點或水的場所。
可能引致熄火、起火、爆炸、短路等，並造成觸電或火災。
- 不平坦或障礙物附近的場所。
本產品可能會跌下來，並導致身體受傷。
- 直接陽光照射、雨淋風吹的位置。
可能引致過熱等並造成觸電或火災。

! 拔除 AC 配接器時，握住 AC 配接器並將它拉出，而不是拉電線。

此舉可能令電源線損壞，引致短路並造成觸電或火災。

⊘ 當 AC 配接器已經連接了電源時，皮膚不要長時間接觸 AC 配接器。

不遵守指示可導致低溫燒傷。

* 低溫燒傷

即使物件只是比體溫高些少，但如果身體某點長時間直接接觸那些物件，仍然可導致低溫燒傷。

⊘ 不要將手指放進本產品的保護網或任何運動的零件。

此舉可能引致受傷。

⊘ 調節風向時，不要將手指放入運作中的零件。

此舉可能引致受傷。

⊘ 請勿拖拉本產品。

此舉可能損壞地板。

⊘ 請勿讓身體對著本產品長時間吹風。

這可能會導致與健康有關的問題。

⊘ 只應使用隨附的遙控器操作。

本產品可能會意外地開始操作，導致身體不適或受傷。

! 以下人士使用本產品時，應特別留意。

(幼兒、老人或不能自行調節體溫者)

讓身體對著本產品長時間吹風，可能會令他們感到不適或脫水。

■ 要求事項：

- 不要將本產品放置於殺蟲劑或油類腐蝕性溶劑附近。
此可對品質產生壞影響，或破壞本產品。
- 不要將本產品放置於高溫、潮濕或多塵的地方。
此可對品質產生壞影響，或破壞本產品。
- 將本產品放置在離開電視機、收音機或其他影音器材 1 米以上的地方使用。不這樣做可導致圖像受干擾或聲音失真。

■ 此產品不適合身體、感官或精神功能遲緩，或缺乏經驗與知識的人（包括兒童）使用，除非他們在負責其安全的人的監督或指引下使用。

■ 請看管好兒童，確保他們不會以本產品玩耍。

■ 本電器只可使用隨附的電源裝置。

■ 本電器必須使用對應本電器上的標記的安全特低電壓。

Safety precautions

Always follow these instructions

To avoid the possibility of causing injury to users or damage to properties, please follow all the explanations written below.

- The following symbols differentiate the levels of danger and injury that may result if the product is improperly used.

 WARNING	This symbol indicates that improper handling may cause a risk of death or serious injury.
--	---

 CAUTION	This symbol indicates that improper handling may cause a risk of injury or damage to properties.
--	--

- The following symbols indicate type of instructions to be observed. (The symbols given below are examples.)

 This symbol denotes an action that is PROHIBITED .	 This symbol denotes a COMPULSORY action.
---	---

 This symbol denotes an action that should be carefully performed.

 WARNING
--

 Always use with the supplied AC adaptor. Failure to do so may cause electric shock, fire or malfunction.
--

 Never try to take apart, repair or modify this product. Ignition or abnormal operation may occur, and cause electric shock, fire or injury. • Contact the dealer for repairing this product.

 Do not use more than the rating of the electrical outlet or wiring accessories. Do not connect this product to power supply except rated voltage and rated frequency. If you exceed the rating using a power strip etc., heat generation may occur and cause fire.
--

 When a failure or malfunction occurs, stop using the product immediately and disconnect AC adaptor. Heat generation etc. may occur and cause electric shock or fire. [Examples of failure/malfunction] • Although connecting to power supply and turning on, the fan does not operate. • Abnormal noise is observed during operation. • Moving the power cord stops operation. • Blade rotates slowly, or irregularly. • Burning smell is observed. • Motor unit, AC adaptor or power cord becomes abnormally hot. Contact the dealer immediately for maintenance/repairing.

 Do not turn on the product unless blade and guard are installed properly. It may cause injury.
--

 When assembling or storing, do not press the height adjustment button unless blade and guard are installed properly. Motor unit and slide pipe may come out rapidly and cause injury.

 Do not damage the power cord or plug of AC adaptor. (Do not cut, modify. Do not forcefully bend, twist or pull. Do not put near heating appliances, or put anything heavy on. Do not bundle.) If damaged power cord or plug is used, short circuit etc. may occur and cause electric shock or fire. • Contact the dealer for repairing the power cord or plug. If the supply cord is damaged, it must be replaced by the manufacturer, its service agent or similarly qualified persons in order to avoid a hazard.

 Make sure the power plug of AC adaptor is fully inserted into socket. Loose engagement of the plug and socket may cause electric shock or fire due to overheat. • Do not use the damaged plug or loosen socket.
--

 Do not connect or disconnect the AC adaptor with wet hands. It may cause electric shock.
--

 Do not place the product on its power cord of AC adaptor. It may damage the power cord, short circuit may occur and cause electric shock or fire.

 Do not use the product with pressing the main body connection plug against wall etc.. It may damage the power cord, short circuit may occur and cause electric shock or fire.

 Do not immerse the product in water, or put water on it. Short circuit may occur and cause electric shock or fire.
--

 Do not place the product near heating appliances. Plastic parts may melt and catch fire.
--

 Do not pull the power cord when carrying and storing away the product. It may damage the power cord, short circuit may occur and cause electric shock or fire.
--

 Do not stretch the power cord during operation. It may damage the power cord, short circuit may occur and cause electric shock or fire.

 Do not swing around the product with the handle.
It may cause injury or damage the product.

 Do not insert the pin, or foreign objects such as metal, into the nanoe™ emission outlet.
It may touch the parts inside and cause electric shock or injury.

 Make sure to disconnect the AC adaptor when assembling, cleaning and storing away the product.
The product may start operating unexpectedly and cause injury or electric shock.

 Wipe off dust on the power plug of AC adaptor periodically.
If the plug is used with dust accumulated on it, humid air etc. may cause poor insulation and fire.
• Disconnect the AC adaptor and wipe it with a dry cloth.
• Disconnect the AC adaptor when not using for a long period.

 Keep the lithium battery out of reach of small children.
Small children may accidentally swallow it. If swallowed, call your doctor for advice immediately.

 **CAUTION**

 Do not use the product at the following locations:

- Where it may be exposed to flammable gas or near sources of flame such as gas ranges.
- Where it is exposed to rain or water.
Flame failure, catching fire, explosion, short circuit, etc. may occur and cause electric shock or fire.
- Where it becomes unstable or place near the obstacles.
The product may fall down and cause injury.
- Where it is exposed to direct sunlight or wind-driven rain.
Overheat etc. may occur and cause electric shock or fire.

 When disconnecting the AC adaptor, grasp and pull the AC adaptor, not the cord.
It may damage the power cord, short circuit may occur and cause electric shock or fire.

 Do not expose skin for a long time to the AC adaptor, while connected to power supply.
It may cause low-temperature burns.
*Low-temperature burns
Touching objects for a long time directly at same point in body, even if it is slightly hotter than body temperature, may cause low-temperature burns.

 Do not put your fingers into the guard or any moving part of the product.
It may cause injury.

 Do not put your fingers into the moving parts when adjusting wind direction.
It may cause injury.

 Do not drag the product.
It may cause damage to the floor.

 Do not expose yourself to wind generated by the product for a long time.
It may cause health related issue.

 Do not operate with the remote control unit other than the supplied.
The product may start operating unexpectedly and cause discomfort or injury.

 Special attention should be paid when people such as the following use this product.
(Infants, children, elderly people, or people who cannot control their own body temperature)
Exposed themselves directly to wind generated by the product for a long time, they may feel sick or get dehydrated.

■ **Notice:**

- Do not place the product near insecticide, oil corrosive solvent. It may cause bad effects on quality, or damage the product.
- Do not place the product in high temperature, high humidity or dusty place.
It may cause bad effects on quality, or damage the product.
- Use the product away more than 1 m from TV, radio, or other AV appliances. Failure to do so may cause picture disturbance or audio distortion.

- This appliance is not intended for use by persons (including children) with reduced physical, sensory or mental capabilities, or lack of experiences and knowledge, unless they have been given supervision or instruction concerning use of the appliance by a person responsible for their safety.
- Children should be supervised to ensure that they do not play with the appliance.
- The appliance is only to be used with the power supply unit provided with the appliance.
- The appliance must only be supplied at safety extra low voltage corresponding to the marking on the appliance.

組裝方法

How to assemble

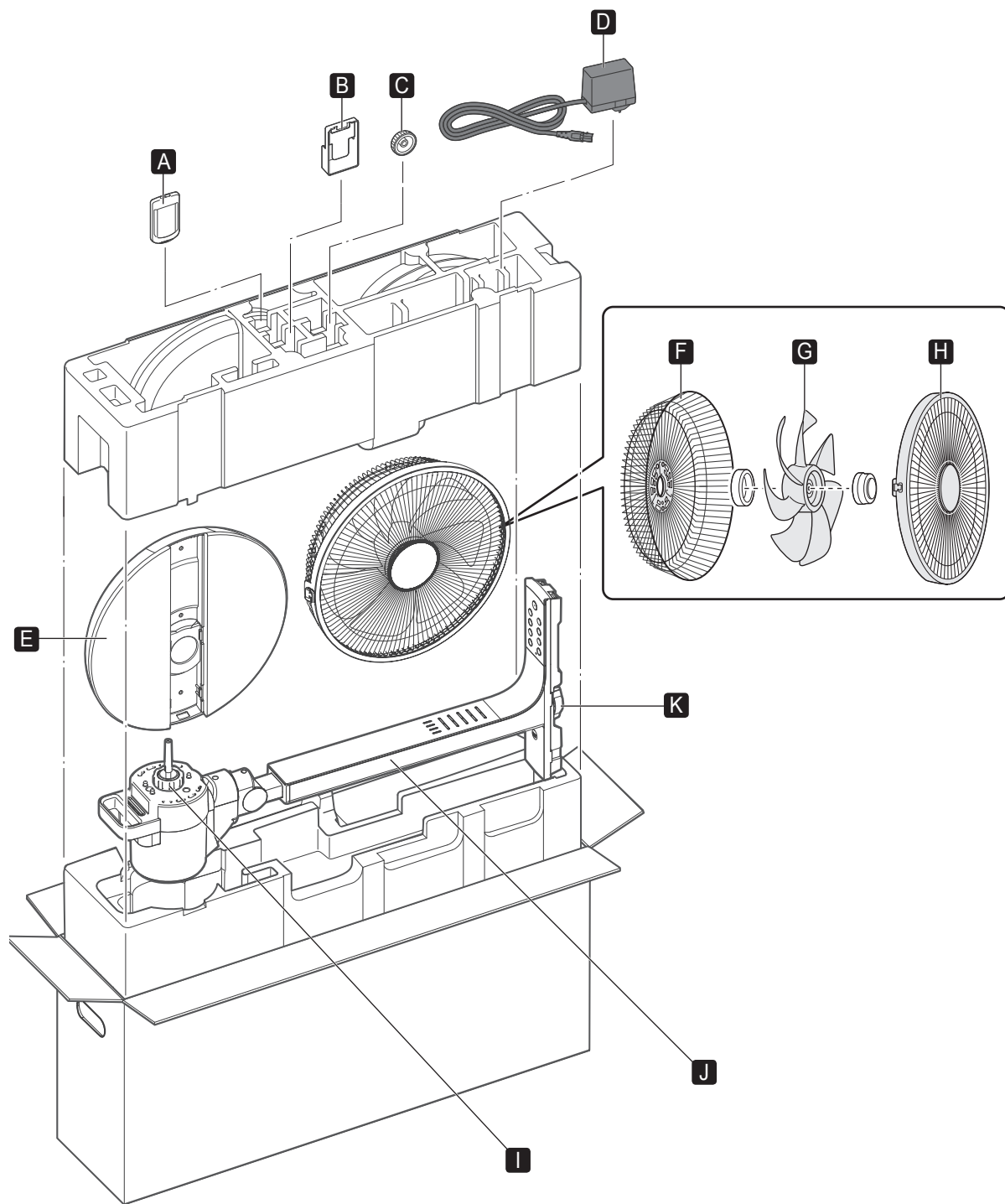

裝嵌前

確保所有零件及配件齊備。
所有零件及配件均如左邊圖包裝著。

- | | | | |
|--------------------------|----------------|------------------------|-----------------|
| A 遙控器 | B 遙控器支架 | C 旋轉器 | D AC 配接器 |
| E 底座 | F 後保護網 | G 扇葉 | H 前保護網 |
| I 螺帽 (將後保護網與馬達接合) | J 架子 | K 螺帽 (將架子與底部接合) | |

Before assembling

Make sure that all the parts and accessories are provided thoroughly.
They are packed as shown in the figure on the left.

- | | | | |
|--|--------------------------------|--|----------------------|
| A Remote control | B Remote control holder | C Spinner | D AC adaptor |
| E Base | F Rear guard | G Blade | H Front guard |
| I Nut (to engage the rear guard with the motor) | J Stand | K Nut (to engage the stand with the base) | |

組裝方法

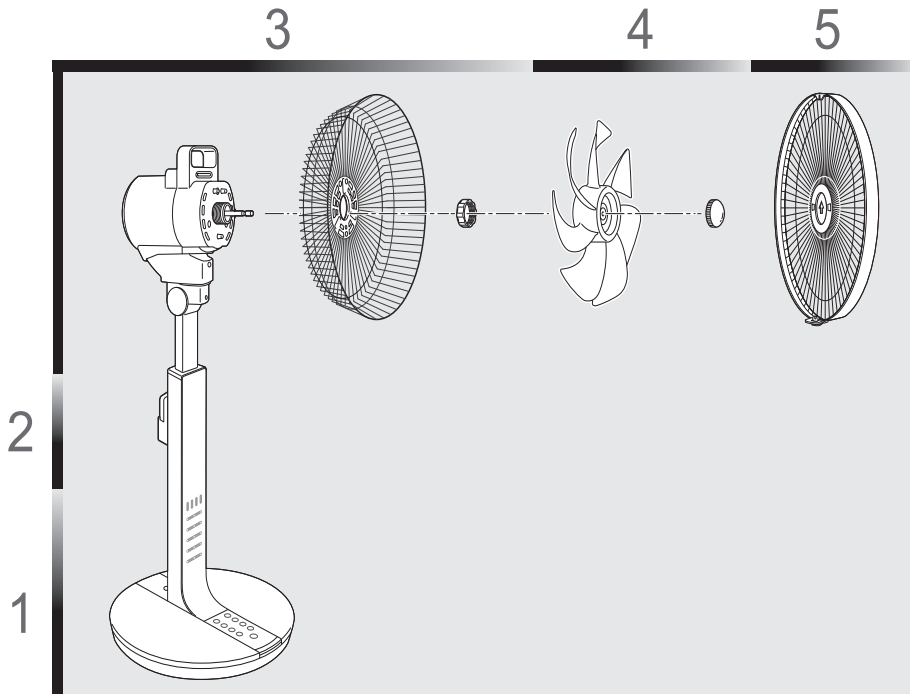

How to assemble

1

安裝架子
▶ 8 頁

Installing the stand
▶ P.8

2

裝上遙控器支架
▶ 9 頁

Attach the remote control holder
▶ P.9

3

安裝後保護網
▶ 9 頁

Installing the rear guard
▶ P.9

4

安裝扇葉
▶ 8 頁

Installing the blade
▶ P.8

5

安裝前保護網
▶ 9 頁

Installing the front guard
▶ P.9

組裝方法

How to assemble

1

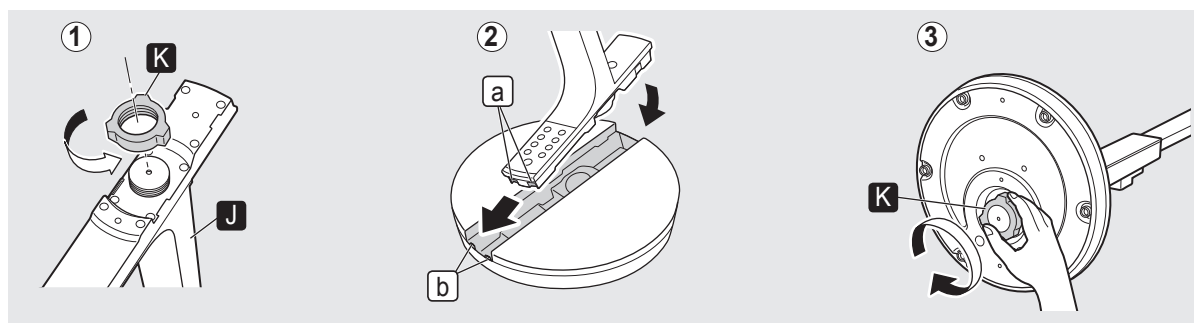

■ 安裝架子

- 1 將架子 J 底部的螺帽 K 移除。
- 2 將底座的凸桿 b 插入架子的凹槽 a 中。
 - 將架子推入底座並固定好。
- 3 如圖將機身安放。
 - 確切地將螺帽 K，將架子固定到底座。
 - 輕輕地安放機身，以免架子從底座跌出。

■ 注意事項：

- 確切地將螺帽擰緊，確保不會鬆脫。

■ Installing the stand

- 1 Remove the nut K at the bottom of the stand J.
- 2 Insert the projection b of the base into the groove a of the stand.
 - Push the stand in the base and secure.
- 3 Lay the main body as shown in the figure. Tighten the nut K to secure the stand to the base.
 - Lay the main body softly to avoid the stand slipping off the base.

■ Attention:

- Tighten the nut securely, not to be loosened.

4

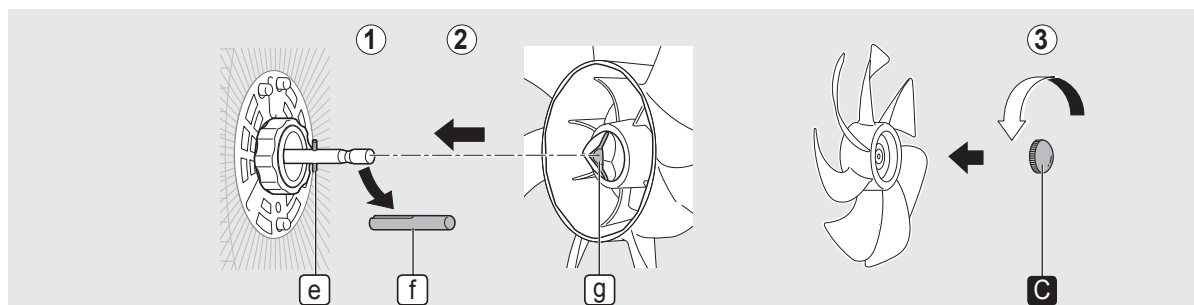

■ 安裝扇葉

- 1 移除蓋子 f，並抹掉馬達軸的油脂。
- 2 對齊馬達軸上的固定針 e 與扇葉的凹位 g。
- 3 擰緊旋轉器 C。

■ 注意事項：

- 確切地擰緊旋轉器，確保電風扇運作時不會鬆脫。

■ Installing the blade

- 1 Remove the cap f and wipe grease off the motor shaft.
- 2 Align the pin e on the motor shaft with the slot in the blade.
- 3 Tighten the spinner C.

■ Attention:

- Tighten the spinner securely, not to be loosened during operation.

2

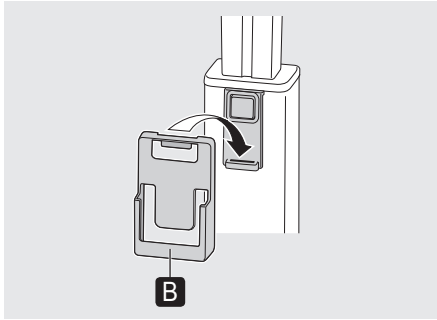

■ 裝上遙控器支架

將遙控器支架 **B** 安裝在架子的背面。

3

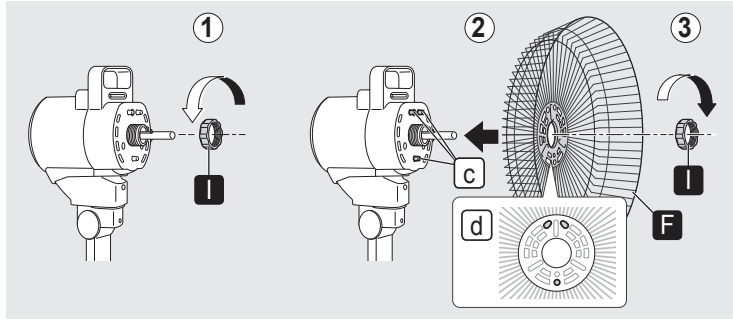

■ 安裝後保護網

① 移除保護網停止器螺帽 **I**。

▶ ② 對齊 3 個凸桿 **c** 及 3 個孔洞 **d**，然後將後保護網 **F** 裝入馬達。

▶ ③ 擰緊保護網停止器螺帽 **I**。

■ 注意事項：

• 確切地擰緊保護網停止器螺帽，確保電風扇運作時不會鬆脫。

■ Attach the remote control holder

Attach the remote control holder **B** at rear side of the stand.

■ Installing the rear guard

① Remove the guard stopper nut **I**.

▶ ② Align each of 3 projections **c** and 3 holes **d**, then fix the rear guard **F** to the motor.

▶ ③ Tighten the guard stopper nut **I**.

■ Attention:

• Tighten the guard stopper nut securely, not to be loosened during operation.

5

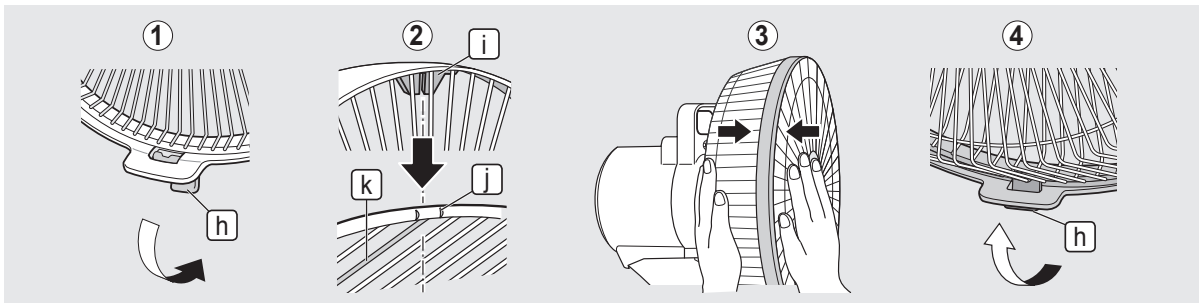

■ 安裝前保護網

① 打開前保護網的夾子 **h**。

▶ ② 對齊前保護網的鉤子 **i** 與後保護網頂部的配合標記 **j**，然後插入線材 **k**。

▶ ③ 對齊和將線材完全插入前保護網及後保護網四周。

▶ ④ 如圖接合夾子 **h**，以固定前保護網及後保護網。

■ 注意事項：• 當打開夾子，請小心不要弄傷手指。

• 將線材完全插入保護網四周，並確切地接合夾子，確保電風扇運作時不會鬆脫。

■ Installing the front guard

① Open the clip **h** of the front guard.

▶ ② Align the hook **i** of front guard with the marked spot **j** at the top of rear guard, then insert the wire rod **k**.

▶ ③ Align and insert all the way around of the front and rear guard.

▶ ④ Engage the clip **h** to fix the front and rear guard as shown in the figure.

■ Attention: • When opening the clip, please be careful not to hurt your fingers.

• Insert all the way around of guard and engage the clip securely, not to be loosened during operation.

各部件名稱

Name of parts

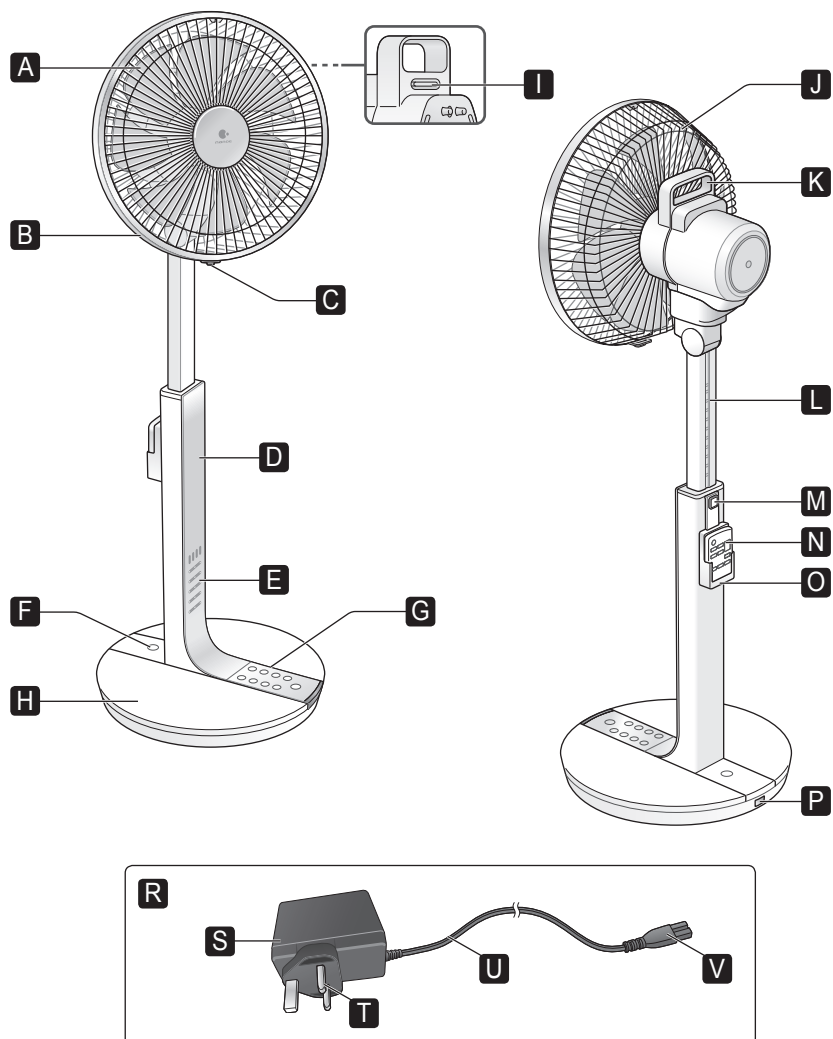

- | | | | |
|----------------------------|----------------|----------------|--------------------|
| A 扇葉 | B 前保護網 | C 夾子 | D 架子 |
| E 指示器 | F 溫度感應器 | G 控制板 | H 底座 |
| I nanoe™ (納米離子) 出風口 | J 後保護網 | K 手柄 | L 升降桿 |
| M 高度調整鈕 | N 遙控器 | O 遙控器支架 | P 機身連接插頭用插座 |

- | | | | | |
|-----------------|-------------------|---------------|--------------|-----------------|
| R AC 配接器 | S AC 配接器器身 | T 電源插頭 | U 電源線 | V 機身連接插頭 |
|-----------------|-------------------|---------------|--------------|-----------------|

只應使用隨附的 AC 配接器。隨附的 AC 配接器只供本產品使用，不要用在其他電器上。

- | | | | |
|-----------------------------------|-----------------------------|--------------------------------|---|
| A Blade | B Front guard | C Clip | D Stand |
| E Display | F Temperature Sensor | G Control panel | H Base |
| I nanoe™ emission outlet | J Rear guard | K Handle | L Slide pipe |
| M Height adjustment button | N Remote control | O Remote control holder | P Socket for the main body connection plug |

- | | | | | |
|---------------------|--------------------------|---------------------|---------------------|------------------------------------|
| R AC adaptor | S AC adaptor body | T Power plug | U Power cord | V Main body connection plug |
|---------------------|--------------------------|---------------------|---------------------|------------------------------------|

Always use with the supplied AC adaptor. The supplied AC adaptor is for this product only. Do not use with other appliances.

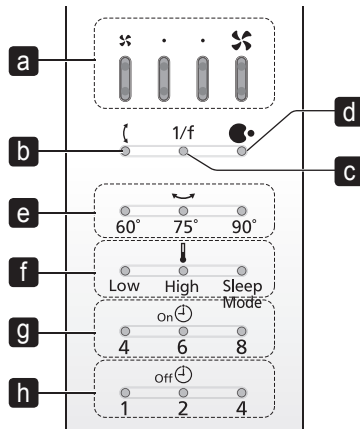

指示器

- a** [風速] 指示燈
- b** [上下擺動] 指示燈
- c** [1/f Yuragi] 指示燈
- d** [nanoe™ (納米離子)] 指示燈
- e** [左右擺動] 指示燈
- f** [溫度感應器] 指示燈
- g** [開機定時器] 指示燈
- h** [關機定時器] 指示燈

Display

- a** [Speed] lamp
- b** [Vertical swing] lamp
- c** [1/f Yuragi] lamp
- d** [nanoe™] lamp
- e** [Horizontal swing] lamp
- f** [Temp. Sensor] lamp
- g** [On timer] lamp
- h** [Off timer] lamp

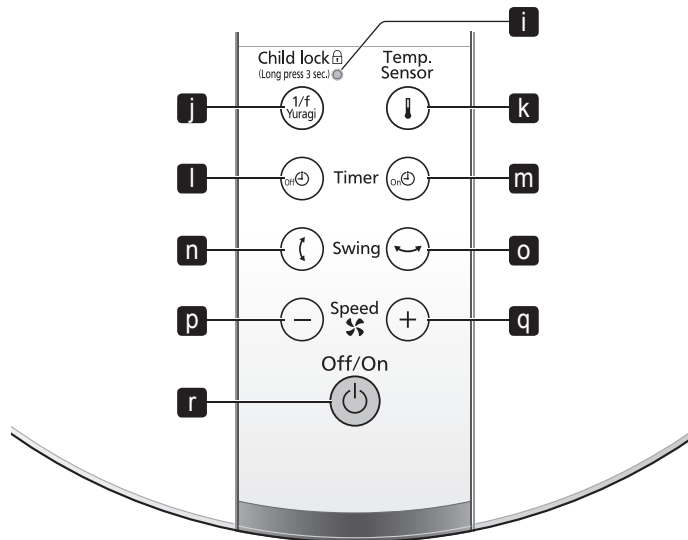

控制板 / 遙控器

- i** [兒童安全鎖] 指示燈
- j** 1/f Yuragi 鈕
- k** 溫度感應器鈕
- l** 關機定時器鈕
- m** 開機定時器鈕
- n** 上下擺動鈕
- o** 左右擺動鈕
- p** 風速鈕 (-)
- q** 風速鈕 (+)
- r** 開/關鈕
- s** NANOE 鈕
- t** 晚間模式鈕

Control panel / Remote control

- i** [Child lock] lamp
- j** 1/f Yuragi button
- k** Temp. Sensor button
- l** Off timer button
- m** On timer button
- n** Vertical swing button
- o** Horizontal swing button
- p** Speed button (-)
- q** Speed button (+)
- r** Off/On button
- s** NANOE button
- t** NIGHT MODE button

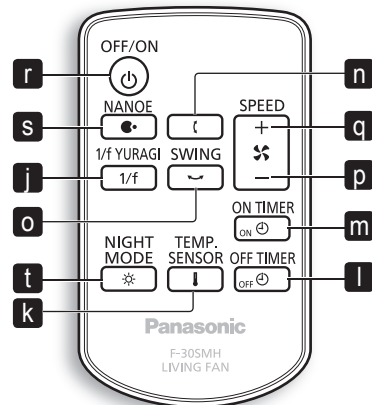

使用方法

How to use

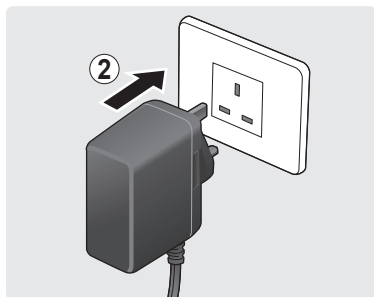
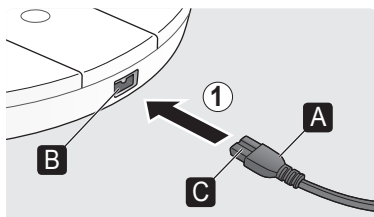

使用前

- ① 將機身連接插頭 **A** 完全插入底座背面的插座 **B**。
• 注意要正確地接駁機身連接插頭。(有凹槽 **C** 的那一面向上)
- ② 接駁 AC 配接器至電源。

Before use

- ① **Insert fully the main body connection plug **A** into the socket **B** at the back of the base.**
• Note that the main body connection plug should be connected correctly. (the side with groove **C** facing up)
- ② **Connect the AC adaptor to the power supply.**

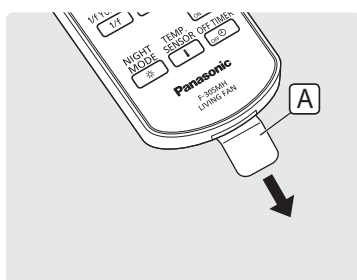

使用遙控器前

- 必先拉出並拆除保護膠紙 **A**。
(請根據當地規定廢棄膠紙。)

Before using the remote control

- You must pull out and remove the protective plastic sheet **A**.
(Please dispose of the sheet according to the local regulations.)

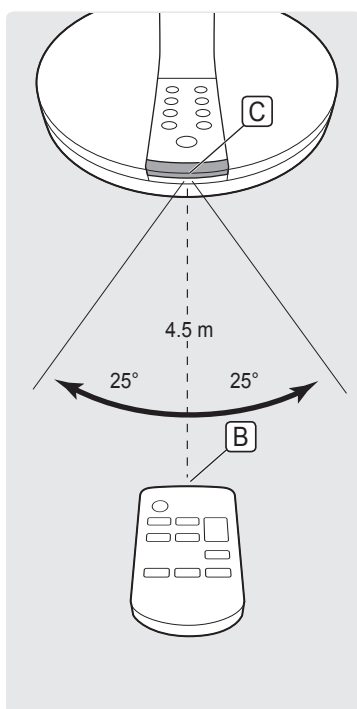

遙控器使用方法

- 將遙控器發射器 **B** 指向接收器 **C**。
 - 有效的操作是距離接收器約 4.5 米，左右兩邊在 25 度以內的範圍。
- **注意事項：**
- 不要讓遙控器接觸液體。敬請小心不要摔下或踏遙控器。此舉可能引致遙控器故障。
 - 不要擋住接收器。此舉將引致遙控器無法操作。
 - 如遙控器不能正常工作，請更換電池。
 - 請不要讓接收器直接受到陽光和強烈照燈的照射。(此舉會引起遙控操作不靈。)
 - 不用遙控器的時候，將它放在遙控器支架內。

How to use the remote control

- Point the remote control transmitter **B** in the direction of the receptor **C**.
- The controllable distance is about 4.5 m from the receptor and 25 degree angle to the right and left.

■ Attention:

- Do not spill liquids on the remote control. Do not drop or step on it. It may damage the remote control.
- Do not cover up the receptor. It prevents the remote control from functioning.
- If the remote control becomes ineffective, replace with a new battery.
- Keep the receptor out of direct sunlight and strong artificial light. (It may diminish the remote control effectiveness.)
- When you do not use the remote control, keep it in the remote control holder.

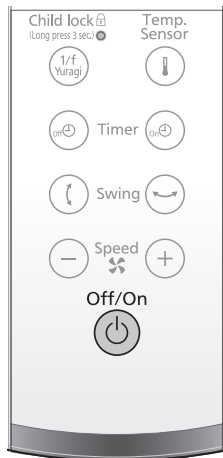

Off/On (開/關)

每次按下按鈕時，進行開關。

- 第一次使用時，電風扇的運作設定是風速“1”及 nanoe™ (納米離子) “開”。
- 風速、定時器、溫度感應器 及 NANOEO 鈕只能在電風扇開啟時使用。

記憶功能

- 電源開啟時，電風扇會使用之前設定的 風速、1/f Yuragi、nanoe™ (納米離子)、溫度感應器 及 搖頭 開始操作。
- 計時器的設定將不會被儲存。
- 拔出插頭後，記憶將會消除。

■ 說明：

- 使用計時器功能以節省能源或避免睡眠時過涼。
- 為了提高升降溫效果，建議使用電風扇時同時開冷氣。
- 按住任何按鈕 8 秒，電風扇會基於安全理由而關閉。
- **長時間不使用時**
關閉電源，並拔除 AC 配接器的電源以節省能源。
電風扇關閉時仍然會消耗大約 0.4 W 的電力。

Off/On

Turn on or off with the button pressed.

- When the first time using, the fan operates at the setting of speed “1” and nanoe™ “On”.
- Speed, Timer, Temp. Sensor and NANOEO buttons are effective only when the fan is turned on.

Memory function

- When turning on, the fan starts operation at previous setting of Speed, 1/f Yuragi, nanoe™, Temp. Sensor and Swing.
- Timer setting will not be retained in memory.
- When unplugged, memory will be deleted.

■ Note:

- Use the timer function in order to save energy or avoid excess cooling while sleeping.
- Combination use of fan and air conditioner is recommended in order to enhance the effect of heating and cooling.
- When pressing and holding any buttons for 8 seconds, the fan turns off for safety.
- **For extended non-use**
Turn off and disconnect the AC adaptor from power supply in order to save energy.
The fan consumes about 0.4 W even when turning off.

使用方法

How to use

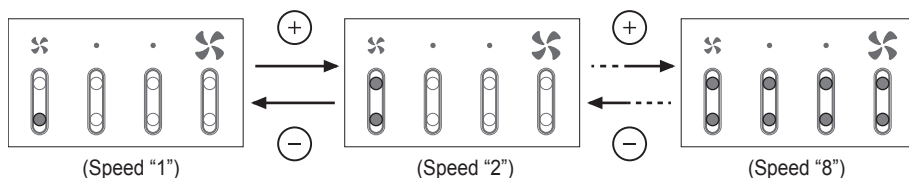
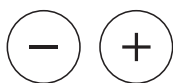
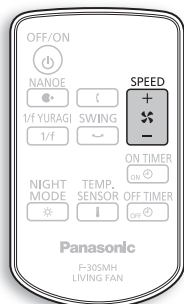

Speed (風速)

— : 減弱 + : 增強

按掣可轉換至另一個風速設定。

- 風速有 8 個級別可供調校。
([風速] 指示燈顯示目前風速。)

Speed (Wind speed)

— : To moderate + : To strengthen

Each press of the button will switch to next wind speed setting.

- Wind speed can be adjusted at 8 levels.
([Speed] lamp indicates current wind speed.)

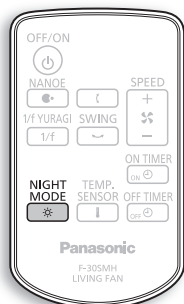
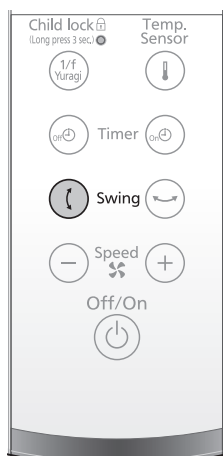

Night mode (晚間模式)

■ 當覺得指示燈刺眼時

睡眠時可以校暗指示燈。

控制板

按住上下擺動鈕 2 秒。

- 按一下按鈕，指示燈會變暗或變光。

遙控器

按 NIGHT MODE 鈕。

- 按一下按鈕，指示燈會變暗或變光。

Night mode

■ When you feel the display lamp is dazzling

You can dim the display lamp when you sleep.

Control panel

Press and hold the Vertical swing button for 2 seconds.

- Display lamps become dim or bright with the button pressed.

Remote control

Press NIGHT MODE button.

- Display lamps become dim or bright with the button pressed.

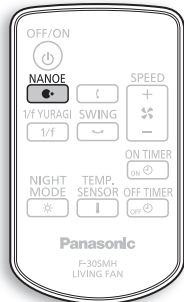
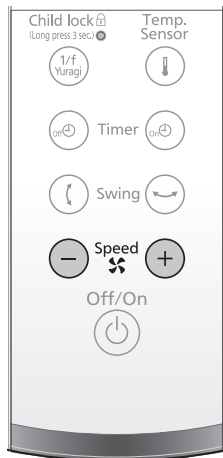

nanoe™ (納米離子)

控制板

同時按住按鈕 3 秒。

遙控器

按 NANOE 鈕。

按一下按鈕開啟或關閉 nanoe™ (納米離子)。(nanoe™ (納米離子)) 指示燈會亮起。)

- nanoe™ (納米離子) 運作時會發出微弱的聲音。
- 第一次使用時，或關機然後再連接電源時，nanoe™ (納米離子) 將會開啟。
- nanoe™ (納米離子) 只會在電風扇運作時發揮功能。
- nanoe™ (納米離子) 有辟除衣服臭味的功效。
 - 如要辟除衣服臭味，將風調校至吹向衣服，使它暴露於 nanoe™ (納米離子) 中。
 - 確保衣服不會碰到前保護網/後保護網。

產生 nanoe™ (納米離子) 的條件

- nanoe™ (納米離子) 產生自周圍的空氣，在某些氣溫及濕度條件下可能無法產生。
- nanoe™ (納米離子) 產生的條件
室溫：約 5 °C 至 35 °C / 露點溫度：2 °C 或以上 / 相對濕度：約 30 % 至 85 %

少量臭氧會產生。

- nanoe™ (納米離子) 運作時會產生少量臭氧。此臭氧量與存在於自然世界的量相同，不會對人有害。

■ 說明：

- nanoe™ (納米離子) 及 nanoe™ (納米離子) 標誌是 Panasonic Corporation 的商標。

nanoe™

Control panel

Press the buttons simultaneously and hold for 3 seconds.

Remote control

Press NANOE button.

nanoe™ operation is turned on or off with the button pressed. ([nanoe™] lamp is lit.)

- During nanoe™ operation, faint sound is heard.
- When the first time using, or when disconnecting and then connecting to power supply again, nanoe™ is turned on.
- nanoe™ can be functioned only while the fan operates.
- nanoe™ is effective to deodorise clothes.
 - Adjust the wind direction for the clothes to be exposed to nanoe™ and deodorised.
 - Make sure that the clothes do not hit the front/rear guards.

Conditions to generate nanoe™

- Because nanoe™ is generated from ambient air, it may not be generated under the certain conditions of temperature and humidity.
- Conditions that nanoe™ is generated
Room temperature: about 5 °C to 35 °C / Dew point: 2 °C or above / Relative humidity: about 30 % to 85 %

A small amount of ozone is generated.

- During nanoe™ operation, a small amount of ozone is generated. It is the same amount as that exists in the natural world and is not harmful to human.

■ Note:

- nanoe™ and the nanoe™ mark are trademarks of Panasonic Corporation.

使用方法

How to use

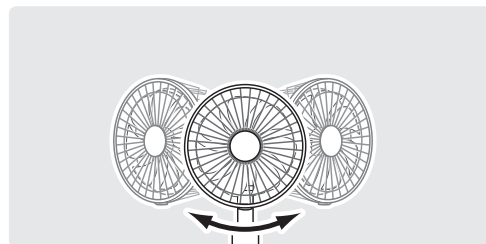
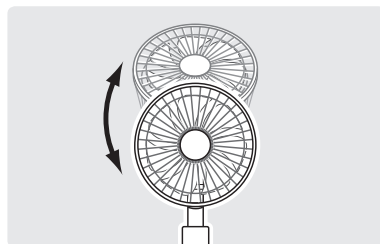
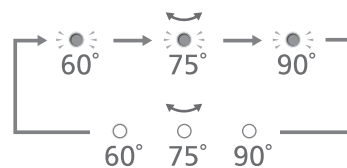
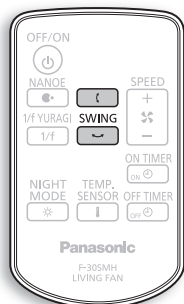

Swing (搖頭)

上下擺動

按一下使電風扇上下擺動。
([上下擺動] 指示燈會亮起。)
再按一下使電風扇停止擺動。
• 擺動角度為向上約 15° 及向下約 5°。

左右擺動

按一下使電風扇左右擺動。
每按一下按鈕將會切換至下一個角度設定。
• [左右擺動] 指示燈顯示目前的設定角度。
• 取消時，所有燈會熄滅。

Swing (Oscillation)

Vertical swing

Press to swing vertically.
([Vertical swing] lamp is lit.)
Press again to stop swing.
• Swing angle is about 15° upward and about 5° downward.

Horizontal swing

Press to swing horizontally.
Each press of the button will switch to next angle setting.
• [Horizontal swing] lamp indicates current setting angle.
• When cancelling, all lamps turn off.

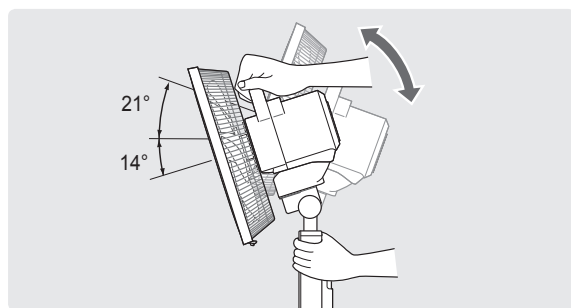

人手調校上下風向

握住機身，拿著手柄並上下擺動，以調校至想要的角度。

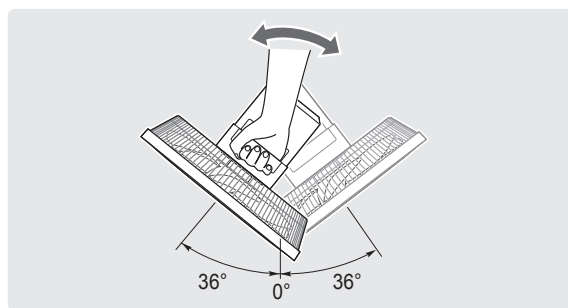

人手調校左右風向

拿著手柄並左右擺動，以調校至想要的角度。

■說明：

• 如要將左右風向調校回原本的位置 (0°)，首先將電風扇轉動至最大的 36°，然後向反方向轉動，直至發出兩下咔嚓聲。最後按開/關鈕。

To adjust the vertical wind direction by hand

Adjust to the desired angle with grasping the main body, holding the handle and oscillating up and down.

To adjust the horizontal wind direction by hand

Adjust to the desired angle with holding the handle and oscillating to right and left.

■ Note:

• To return the horizontal wind direction to the original position (0°), firstly turn to maximum 36° and then turn in the opposite direction until it clicks twice, lastly press Off/On button.

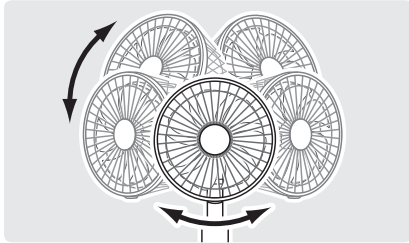
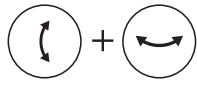

組合

上下及左右擺動按鈕的組合可造出立體擺動的運作。

■ 說明：

- 設定左右擺動角度或恢復左右擺動運作後，電風扇可能會在最盡的位置停止擺動以偵測角度，又或者會發出咔嗒聲。

Combination

Combination of vertical and horizontal swing buttons enables to operate with three-dimensional swing.

■ Note:

- After setting horizontal swing angle or resuming operation with horizontal swing, it may stop swing at the end position temporarily to detect the angle, or clicking sound may be heard.

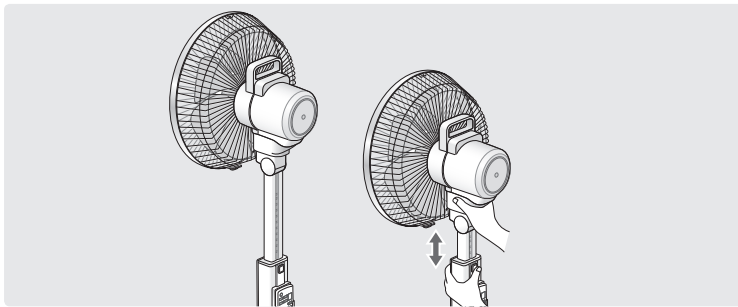

調校升降桿高度的方法

按一下高度調整鈕以解鎖和使升降桿可調校高度。

■ 注意事項：

- 提起前請先確保升降桿已固定。
- 如果提高升降桿或按高度調整鈕時有困難，請先推低升降桿，然後按高度調整鈕並提高升降桿。

How to adjust the height of slide pipe

Press the height adjustment button to release the lock and enable to adjust the height of slide pipe.

■ Attention:

- Make sure to fix the slide pipe before carrying.
- When you have difficulty in raising up the slide pipe or pressing the height adjustment button, once push down the pipe, then press the button and raise the pipe.



注意



不要將手指放入運作中的零件。

此舉可能引致受傷。



CAUTION



Do not put your fingers into the moving parts.

It may cause injury.

使用方法

How to use

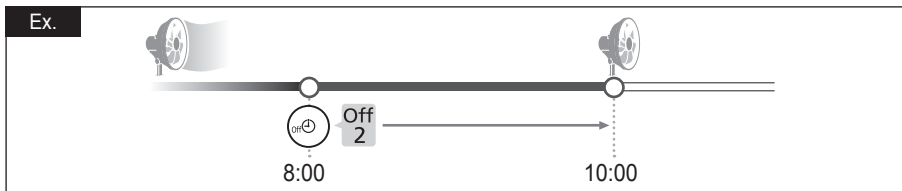
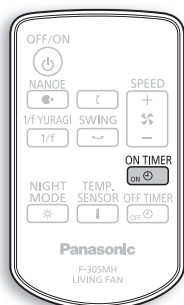
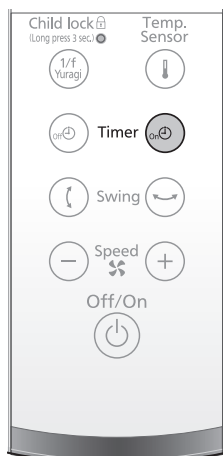
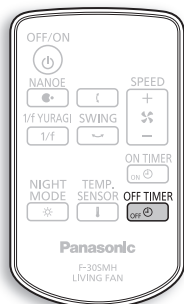
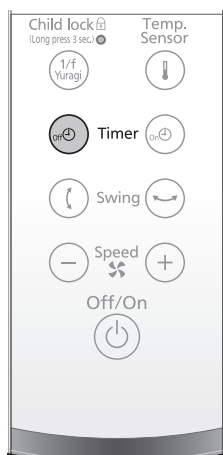

Off timer (關機定時器)

按掣可轉換至另一個定時設定。([關機定時器] 指示燈顯示設定時間。)

- 取消時，所有燈會熄滅，但風扇會繼續運作。
- 隨著時間經過，指示燈會顯示大約的剩餘時間。
- 過了預設的時間後，電風扇會停止運作。
- 此按鈕只能在電風扇開啟時使用。(電風扇關閉時無法設定。)

▲ Ex. (例子)：於 8:00 設定關機定時器為 [2]

Off timer

Each press of the button will switch to next timer setting. ([Off timer] lamp indicates the setting hours.)

- When cancelling, all lamps turn off and the fan operates continuously.
- The fan stops operation when the preset hours has passed.
- As time elapses, the lamp shows the approximate remaining time.
- The button is effective only when the fan is turned on. (You cannot set while the fan is turned off.)

▲ Ex. (Example): When setting Off timer [2] at 8:00

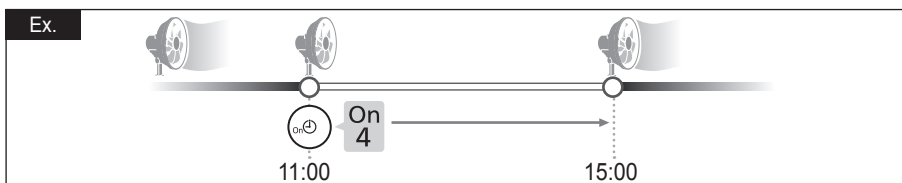

On timer (開機定時器)

按掣可轉換至另一個定時設定。([開機定時器] 指示燈顯示設定時間。)

- 過了預設的時間後，電風扇會停止運作，然後恢復運作。
- 隨著時間經過，指示燈會顯示電風扇恢復運作前大約的剩餘時間。
- 此按鈕只能在電風扇關閉時使用。(電風扇關閉時無法設定。)
- 設定開機定時器後，即使電風扇已經關閉，仍然可設定風速、搖頭、兒童安全鎖、1/f Yuragi、溫度感應器及 nanoe™ (納米離子)。
- 說明：
 - 設定開機定時器時，所有指示燈會變暗。
 - ▶ 如要將燈變亮 (P.14)

▲ Ex. (例子)：於 11:00 設定開機定時器為 [4]

On timer

Each press of the button will switch to next timer setting. ([On timer] lamp indicates the setting hours.)

- The fan stops operation and resumes when the preset hours has passed.
- As time elapses, the lamp shows the approximate time before the fan resuming operation.
- The button is effective only when the fan is turned on. (You cannot set while the fan is turned off.)
- When On timer is set, you can set Speed, Swing, Child lock, 1/f Yuragi, Temp. Sensor operation and nanoe™ even while the fan is turned off.
- Note:
 - When setting On timer, all the display lamps are dimmed.
 - ▶ To brighten the lamp (P.14)

▲ Ex. (Example): When setting On timer [4] at 11:00

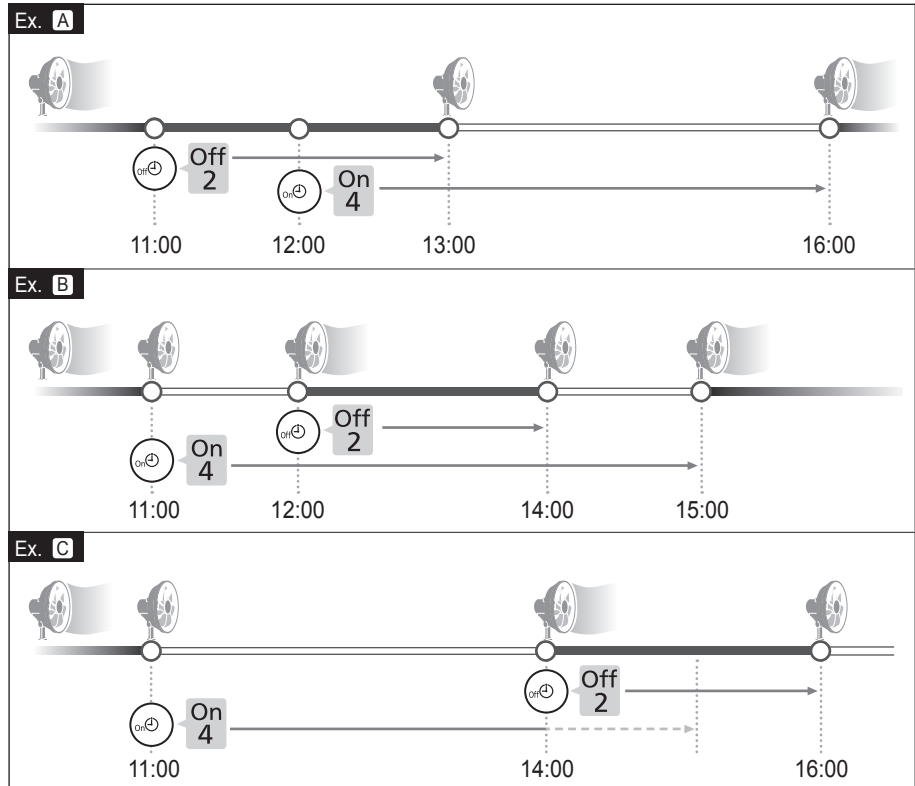
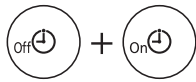
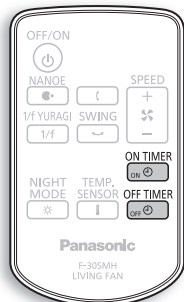
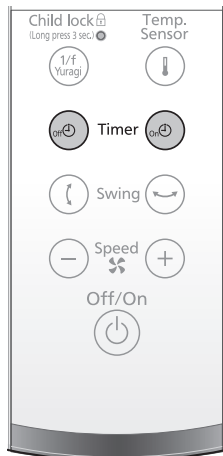

使用方法

開機／關機定時器設定的組合

- 開機及關機定時器可以同時設定。
- 過了預設的關機定時器時間後，電風扇會停止運作。
過了預設的開機定時器時間後，電風扇會恢復運作。
- ▲ **Ex. A** (例子)：於 11:00 設定關機定時器為 [2]，並於 12:00 設定開機定時器為 [4]
 - 電風扇於 13:00 停止運作，並於 16:00 恢復運作。
- ▲ **Ex. B** (例子)：於 11:00 設定開機定時器為 [4]，並於 12:00 設定關機定時器為 [2]
 - 在電風扇已關閉並在已經設定了開機定時器的情況下設定關機定時器時，系統將會優先處理關機定時器的設定。
- ▲ **Ex. C** (例子)：於 11:00 設定開機定時器為 [4]，並於 14:00 設定關機定時器為 [2]
 - 如果關機定時器的剩餘時間開始計算前已到了開機定時器的恢復時間，則開機定時器的設定會被取消。

Combination of Off/On timer setting

- You can set Off and On timer simultaneously.
- **When the preset hours of off timer has passed, the fan stops operation. When the preset hours of on timer has passed, the fan resumes operation.**
- ▲ **Ex. A** (Example): **When setting Off timer [2] at 11:00 and On timer [4] at 12:00**
 - The fan stops operation at 13:00, and resumes at 16:00.
- ▲ **Ex. B** (Example): **When setting On timer [4] at 11:00 and Off timer [2] at 12:00**
 - When you set Off timer during the fan turning off with On timer, Off timer setting is priority.
- ▲ **Ex. C** (Example): **When setting On timer [4] at 11:00 and Off timer [2] at 14:00**
 - When the time to resume with On timer comes before the remaining time of Off timer, On timer is canceled.

How to use

使用方法

How to use

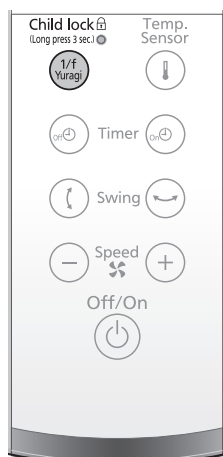

Child lock (兒童安全鎖)

按住 1/f Yuragi 鈕 3 秒。([兒童安全鎖] 指示燈會亮起。)
再按住 1/f Yuragi 鈕 3 秒以取消。

- 只可使用控制板設定兒童安全鎖。
- 如果在電風扇運作時設定兒童安全鎖，唯一可做到的是關閉電風扇或取消兒童安全鎖。(關閉電風扇後，如果想恢復運作，必須取消兒童安全鎖。)
- 如果電風扇關閉時設定兒童安全鎖，唯一可做到的是取消兒童安全鎖。

Child lock

Press and hold 1/f Yuragi button for 3 seconds. ([Child lock] lamp is lit.)
Press and hold the button for 3 seconds again to cancel.

- You can set Child lock with the control panel only.
- If you set Child lock during operation, only what you can do is to turn off or to cancel Child lock. (After turning off, if you want to resume operation, you must cancel Child lock.)
- If you set Child lock while the fan is turned off, only what you can do is to cancel Child lock.

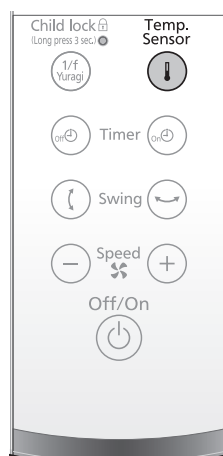

溫度感應器運作 (自動控制溫度感應器)

透過溫度感應器探測室溫，電風扇會自動控制風速。

每按一下按鈕會切換至下一個模式設定。([溫度感應器] 指示燈顯示目前設定。)
按風速鈕以取消溫度感應器運作。

■ 說明：

當睡眠模式運作時

- 所有指示燈會變暗。▶ 如要將燈變亮 (14 頁)
- 當睡眠模式運作時按風速鈕，睡眠模式會被取消。如要再次啟動睡眠模式，按溫度感應器鈕，然後選擇睡眠模式。
- 如要睡眠時自動停止運作，請設定關機定時器。

關閉睡眠模式運作後

- 按開/關鈕，電風扇會以上次同樣的風速啟動睡眠模式運作。以開機定時器恢復運作時，電風扇會以上次停止運作時同樣的風速啟動睡眠模式運作。

■ 注意事項：

- 不要遮蓋溫度感應器。否則會阻礙感應器正確偵測溫度。
- 於低溫模式或高溫模式，就算電風扇似乎已停止，但電源是尚未關閉的。
不使用時，按開/關鈕以停止。

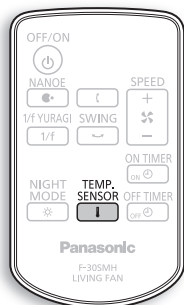

Temp. Sensor operation (Automatic control with temperature sensor)

Detecting room temperature with the temperature sensor, the fan controls wind speed automatically.

Each press of the button will switch to next mode setting. ([Temp. Sensor] lamp indicates current setting.)
Press Speed button to cancel Temp. Sensor operation.

■ Note:

During Sleep mode operation

- All the display lamps are dimmed. ▶ To brighten the lamp (P.14)
- When pressing Speed button, Sleep mode is canceled. To return Sleep mode, press Temp. Sensor button and select Sleep mode again.
- To stop operation automatically while sleeping, set Off timer.

After turning off sleep mode operation

- Pressing Off/On button, the fan starts sleep mode operation at the same wind speed as last time.
Resuming with On timer, the fan starts sleep mode operation at the same wind speed as when stopping.

■ Attention:

- Do not cover up the temperature sensor. It prevents the sensor from detecting correctly.
- In Low mode or High mode, even if the fan seems to stop, it is not off the power.
Press Off/On button to stop, when not using.

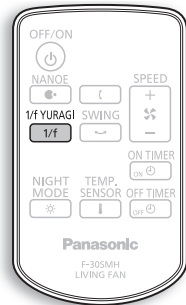
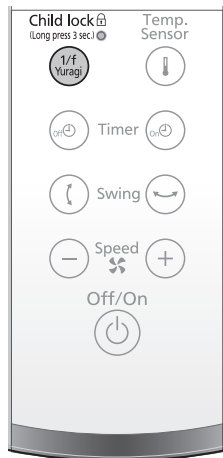

1/f Yuragi

按一下按鈕以開啟或關閉 1/f Yuragi 運作。(1/f Yuragi 指示燈會亮起。)

1/f Yuragi

- 1/f Yuragi 能夠精細地及自動控制風速，讓人享受自然及舒適的微風。

1/f Yuragi

1/f Yuragi operation is turned on or off with the button pressed. ([1/f Yuragi] lamp is lit.)

1/f Yuragi

- 1/f Yuragi enables you to enjoy natural, comfortable breeze by controlling the wind speed finely and automatically.

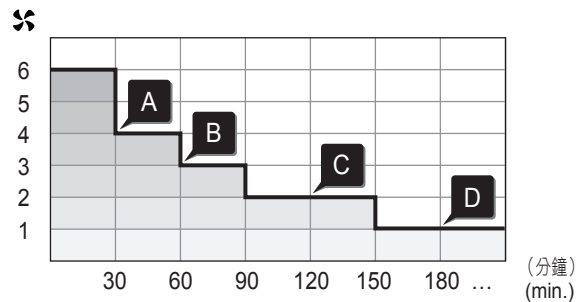
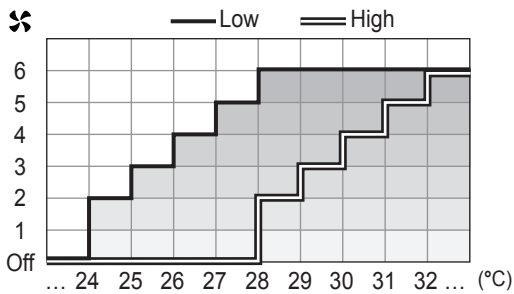

Low (低溫) / High (高溫)

- 電風扇會因應室溫將風速控制於 2 至 6 級之間。
 - 室溫降低後，電風扇會繼續以目前風速運作 5 分鐘，然後才切換至溫和風速。
 - 於低溫模式，當室溫低於 24 °C 時，電風扇會暫停運作。
 - 於高溫模式，當室溫低於 28 °C 時，電風扇會暫停運作。
 - 如果在電風扇暫停運作期間設定睡眠模式，電風扇會以風速 1 恢復運作。
- * 室溫會因應所在地點而有所不同。它可能會與溫度計所顯示的有差別。

Low / High

- Depending on room temperature, the fan controls wind speed in the range from 2 to 6.
 - When room temperature is lowered, the fan continues operation at current speed for 5 minutes and then switch to gentle wind speed.
 - In Low mode, the fan pauses operation while room temperature is below 24 °C.
 - In High mode, the fan pauses operation while room temperature is below 28 °C.
 - During the fan pausing operation, if you set sleep mode, the fan resumes operation at wind speed 1.
- * Room temperature differs by its location. It may be different from the indication of your thermometer.

Sleep mode (睡眠模式)

電風扇每 30 分鐘探測室溫一次。它會因應室溫轉變而將風速控制於 1 至 4 級之間。

- A** 當風速處於 5 至 8 級之間時設定睡眠模式，電風扇會於 30 分鐘後將風速切換至 4 級。
- B** 當室溫維持不變或下降時，電風扇會將風速降低一級。
- C** 當室溫上升時，電風扇會維持目前風速。
- D** 當風速達到 1 級時，電風扇會繼續以風速 1 運作。就算室溫低於 24 °C，電風扇都不會停止運作。

Sleep mode

The fan detects room temperature every 30 minutes. Depending on room temperature change, it controls wind speed in the range from 1 to 4.

- A** Setting Sleep mode when wind speed is in the range from 5 to 8, the fan switches wind speed to 4, after 30 minutes.
- B** When room temperature keeping or falling, the fan reduces wind speed by one level.
- C** When room temperature rising, the fan keeps current wind speed.
- D** When wind speed reaches to 1, the fan continues operation at wind speed 1. Even if room temperature is below 24 °C, the fan does not stop operation.

在必要時

When necessary

保養

清潔前確保已拔除 AC 配接器。

使用以加入了廚房用清潔劑的溫水浸濕的軟布擦去污漬，並用乾布擦淨。

■ 注意事項：

- 為了避免留痕，使用乾布擦表面時，切勿過度用力。
- 請勿使用稀釋劑（天拿水）、揮發油、酒精、去污粉或鹼性洗潔劑等。
- 如用化學清潔劑時，必須按照所指示來進行。

Cleaning

Make sure to disconnect the AC adaptor before cleaning.

Use soft cloth soaked in warm water with detergent. Wipe with dry cloth.

■ Attention:

- To avoid scratching the surface, please do not rub too hard with dry cloth.
- Do not use thinner, benzine, alcohol, cleaning powder, alkaline detergent, etc.
- When using chemical detergent, follow its instructions.

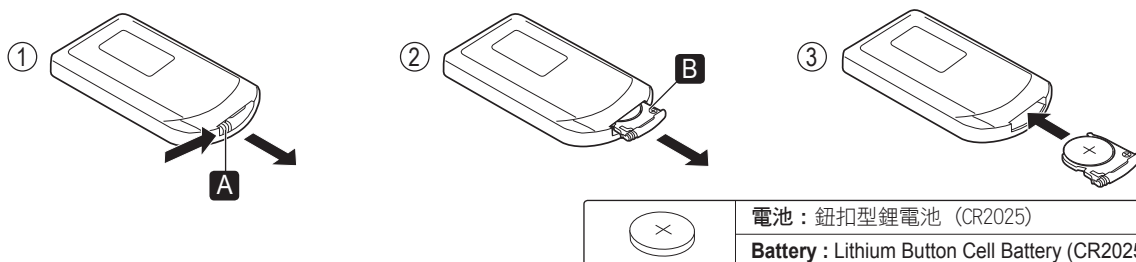

如何更換電池

- ① 翻轉遙控器。把卡榫 **A** 推向右，然後拉出。
- ② 拉出電池座 **B** 並更換電池。
 - 請使用指定電池類型。
(鈕扣型鋰電池 (CR2025))
 - 裝入時，電池的正極面必須向上。
- ③ 裝回電池座 **B**。

■ 說明：

- 隨附的電池於出貨時已經安裝，因此它的使用壽命可能較短。

■ 要求事項：

- 請勿對電池座過分施力。
- 長時間不使用時，請取走電池。
- 廢棄用完的電池時，請聯絡當地有關部門或經銷商，了解正確廢棄方法。
(使用透明膠紙等的東西遮蓋，使之絕緣。)



警告



把鋰電池放在幼童觸及不到的地方。
幼童可能意外吞下。如出現此情況，請立即就醫。

How to replace the battery

- ① Turn over the remote control. Press tab **A** toward the right and pull in front.
- ② Pull out the battery holder **B** and replace the battery.
 - Use the specified battery type. (Lithium Button Cell Battery (CR2025))
 - The battery must be installed with the positive side facing up.
- ③ Insert the battery holder **B** back.

■ Note:

- Because the supplied battery is installed when shipping, life may be short.

■ Notice:

- Do not apply excessive force to the battery holder.
- Remove the battery when not using for a long period.
- When disposing of used battery, please contact your local authorities or dealer and ask for the correct method of disposal. (Insulate it by covering with cellophane tape etc..)



WARNING



Keep the lithium battery out of reach of small children.

Small children may accidentally swallow it. If swallowed, call your doctor for advice immediately.

排解疑難

要求維修服務前，請檢查以下項目。如果問題仍然存在，請拔除 AC 配接器的電源及底座上的機身連接插頭，然後聯絡零售商安排維修。

故障現象	檢查
按開／關鈕啟動時扇葉不轉動。	<ul style="list-style-type: none"> AC 配接器是否已經完全及正確地連接？ [兒童安全鎖] 指示燈亮起了嗎？(20 頁) 保護網是否變了形，或碰到扇葉？ 溫度感應器運作是否被設為「開」？(21 頁)
扇葉轉動時發出異常聲音。	<ul style="list-style-type: none"> 扇葉及保護網是否已經正確地安裝？(8-9 頁) 保護網是否變了形，或碰到扇葉？
按鈕後電風扇沒有運作。	<ul style="list-style-type: none"> [兒童安全鎖] 指示燈亮起了嗎？(20 頁)
遙控器沒有反應。	<ul style="list-style-type: none"> 保護膠紙是否已經被拿走？(12 頁) 電池是否已經正確地安裝？(22 頁) 電池是否無電？(12 頁)
nanoe™ (納米離子) 出風口發出異常聲音。	<ul style="list-style-type: none"> nanoe™ (納米離子) 運作時會發出微弱的聲音。因應不同情況或組合運作模式，nanoe™ (納米離子) 產生部會發出響亮或極微弱的聲音。這並非故障。 ▶ 如果感到煩擾，請關閉 nanoe™ (納米離子) 運作。(15 頁)
雖然已經設定溫度感應器運作，但電風扇沒有按照設定的溫度運作。	<ul style="list-style-type: none"> 室溫會因應所在地點而有所不同。它可能會與溫度計所顯示的有差別。(21 頁)
左右擺動角度變窄。	<ul style="list-style-type: none"> 用手或任何物件阻礙電風扇擺動可導致運作異常。 ▶ 關機再開機，電風扇即正常擺動。
電風扇停止運作。	<ul style="list-style-type: none"> 按住任何按鈕 8 秒，電風扇會基於安全理由而關閉。按一下開／關鈕，電風扇便會恢復運作。
所有 [風速] 指示燈都閃爍。	<ul style="list-style-type: none"> 電風扇運作時是否有異物碰到扇葉，使它停止了轉動？ ▶ ① 拔除 AC 配接器的電源。 ▶ ② 拿走使轉動停止的異物。 ▶ ③ 連接 AC 配接器，然後再次開啟電源。

如果出現以下情況，請立刻聯絡零售商。

[溫度感應器] 指示燈閃爍。	<ul style="list-style-type: none"> 溫度感應器發生故障。 ▶ 聯絡零售商安排維修。
----------------	--

在必要時

Troubleshooting

Before requesting service, please check the following. If the problem still persists, disconnect the AC adaptor from power supply, and the main body connection plug from the base, and then contact the dealer for repairing.

Symptom	Check
The blade does not rotate when pressing Off/On button to start.	<ul style="list-style-type: none"> Is the AC adaptor connected fully and correctly? Is Child lock lamp lit? (P.20) Is the guard deformed, or does it hit the blade? Is Temp. Sensor operation controlled at "On"? (P.21)
The blade rotates, but abnormal sound is heard.	<ul style="list-style-type: none"> Are the blade and guards installed correctly? (P.8-9) Is the guard deformed, or does it hit the blade?
The fan does not operate with the button pressed.	<ul style="list-style-type: none"> Is Child lock lamp lit? (P.20)
The remote control does not function.	<ul style="list-style-type: none"> Is the protective plastic sheet removed? (P.12) Is the battery exhausted? (P.12) Is the battery installed correctly? (P.22)
Abnormal sound is heard from the nanoe™ emission outlet.	<ul style="list-style-type: none"> During nanoe™ operation, faint sound is heard. According to the circumstances or combined operation mode, it may sound loud or too faint. It is not malfunction. ▶ If it is annoying, turn off nanoe™ operation. (P.15)
Although Temp. Sensor operation is set, the fan does not operate based on the temperature.	<ul style="list-style-type: none"> Room temperature differs by its location. It may be different from the indication of your thermometer. (P.21)
Horizontal swing angle become small.	<ul style="list-style-type: none"> Clogging swing operation by hand or any objects, abnormal operation may occur. ▶ Turning off and turning on again, the fan operates normally swing.
The fan stops operation.	<ul style="list-style-type: none"> When pressing and holding any buttons for 8 seconds, the fan turns off for safety. The fan resumes operation with Off/On button pressed.
All [Speed] lamps blink.	<ul style="list-style-type: none"> Does foreign object hit and stop the rotation of blade during operation? ▶ ① Disconnect the AC adaptor from power supply. ▶ ② Remove the foreign object stopping the rotation. ▶ ③ Connect the AC adaptor and turn on again.

Please contact the dealer immediately in the case below.

[Temp. Sensor] lamp blinks.	<ul style="list-style-type: none"> Temperature sensor is malfunctioned. ▶ Contact the dealer for repairing.
-----------------------------	---

When necessary

規格

Specifications

數值是當電風扇以風速“8”運作時。

電壓 (V~)	頻率 (Hz)	耗電量 (W)	轉速 (r / min.)	風速 (m / min.)	風量 (m ³ / min.)	左右擺動角度	電線長度 (m)	重量 (kg)	尺寸 (mm)
220-240	50	22	1100	144	50	60° 75° 90°	2.0	7.5	高 905-1100 闊 370 深 370

• 將電風扇連接至電源但不開機，耗電量大約是 0.4 W。

The values are when the fan operates at wind speed “8”.

Voltage (V~)	Frequency (Hz)	Power (W)	r.p.m. (r / min.)	Air Velocity (m / min.)	Air Volume (m ³ / min.)	Horizontal swing angle	Cord Length (m)	Weight (kg)	Dimension (mm)
220-240	50	22	1100	144	50	60° 75° 90°	2.0	7.5	H 905-1100 W 370 D 370

• When connecting the fan to power supply but turning off, the consumption power is about 0.4 W.

Panasonic Corporation

Web site: <http://panasonic.net/>

© Panasonic Corporation 2014

30SMH8991 C
M1113Y1014