

Aftersales services 售後服務

Panasonic official website: <http://www.panasonic.hk>

Panasonic 官方網站網址: <http://www.panasonic.hk>

Panasonic®

Operating Instructions 使用說明書

Kettle (Household Use)

電熱水壺 (家庭用)

Model No.
型號 **NC-HKD121**

English

中文 (繁體)



Panasonic Taiwan Co., Ltd.

© Panasonic Taiwan Co., Ltd. 2017

Printed in China

Date of issue: October 2017

PZ05H708
MD1017E0

Thank you for purchasing the Panasonic product.

- This product is intended for household use only.
- This product can only use for boiling water, it does not have thermal insulation function.
- Please read these instructions carefully to use the product correctly and safely.
- **Before using this product please give your special attention to “Safety Precautions” and “Important Information” (Page EN3-8).**
- Please keep this Operating Instructions for future use.
- Panasonic will not accept any liability if the appliance is subject to improper use, or failure to comply with these instructions.

Contents

	Page
Safety Precautions	EN3
Important Information	EN8
Parts Names and Handling Instructions	EN9
How to Use	EN10
How to Clean	EN12
Troubleshooting	EN13
Specifications	EN15

Safety Precautions

Please make sure to follow these instructions

In order to prevent accidents or injuries to the user, other people, and damage to property, please follow the instructions below.

■ **The following charts indicate the degree of damage caused by wrong operation.**

 **WARNING:** Indicates potential hazard that could result in serious injury or death.

 **CAUTION:** Indicates potential hazard that could result in minor injury or property damage.

■ **The symbols are classified and explained as follows.**

 This symbol indicates an action that must be avoided.

 This symbol indicates an action that must be carried out.

WARNING

To avoid risk of electric shock, fire due to short circuit, smoke, burn or injury.

- **Do not disassemble, repair or modify this appliance.**
→ Consult the place of purchase or a Panasonic service center.
- **Do not damage the power cord or power plug.**
Following actions are strictly prohibited.
Modifying or placing near heating element, bending, twisting, pulling along, pulling over sharp edges, putting heavy objects on top, bundling the power cord and carrying the appliance by the power cord.
- **Do not use the appliance if the power cord or power plug is damaged or the power plug is loosely connected to the outlet.**
→ If the power cord is damaged, it must be replaced by the manufacturer, its service agent or similarly qualified person in order to avoid a hazard.

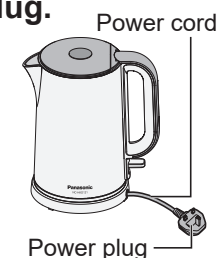

Safety Precautions

Please make sure to follow these instructions

WARNING

To avoid risk of electric shock, fire due to short circuit, smoke, burn or injury.

-  ● Do not plug or unplug the power plug with wet hands.
- Do not immerse the appliance (include the power base and power base connector), power cord and power plug in water or splash it with water and / or any liquid.
 - Do not allow the bottom of the appliance to get wet when filling directly from the tap or placing it in the sink.
- Do not let the power cord hang over the edge of table or worktop, or touch hot surfaces.
- Do not allow infants and children to play with packaging material.
(It may cause suffocation.)
- Do not allow foreign material (especially metal components such as pins and wires or dust) to adhere to the body connector or power base connector.
- Do not touch or put your face close to the spout during or after use.
 - Especially keep the appliance out of reach of infants and children.
- Do not block the spout with a cloth etc.
- Do not close the lid vigorously.
- Do not fill with any substance other than water. This appliance is for boiling water only.
- Do not shake or tip over the body.
- Do not use to store ice cubes.
- Do not put the body on any heat source or in a microwave.
- Do not lick the power base connector.
 - Pay attention when infants and children are near the appliance.
- Make sure close the lid firmly.

EN4

WARNING

To avoid risk of electric shock, fire due to short circuit, smoke, burn or injury.

-  ● This appliance is not intended for use by persons (including children) with reduced physical, sensory or mental capabilities, or lack of experience and knowledge, unless they have been given supervision or instruction concerning use of the appliance by a person responsible for their safety. Children should be supervised to ensure that they do not play with the appliance.
- Always keep the infants and children away from the appliance including power cord.
- Insert the power plug firmly.
- Dust off the power plug regularly.
 - Unplug the power plug, and wipe with a dry cloth.
- Discontinue using the appliance immediately and unplug in the unlikely event that this appliance stops working properly. e.g. for abnormal or breaking down
 - The power plug and the power cord become abnormally hot.
 - The power cord is damaged or the appliance power fails.
 - The main unit is deformed, has visible damage or is abnormally hot.
 - Water leaks from the body.
 - The steam continues more than 3 minutes.
 - There is another abnormality or failure.
 - Unplug the appliance immediately and contact to the service center for the check or the repair.

English

EN5

Safety Precautions

Please make sure to follow these instructions

WARNING

To avoid risk of electric shock, fire due to short circuit, smoke, burn or injury.

-  ● Make sure the voltage indicated on the label of the appliance is the same as your local supply. Also avoid plugging other devices into the same outlet to prevent electrical over heating. However, if you are connecting a number of power plugs, make sure the total wattage does not exceed the rated wattage of the outlet.
- Do not pour water above the maximum water level indication line. If the appliance is overfilled, boiling water may be ejected.



CAUTION

To avoid risk of electric shock, fire, burn, injury or property damage.

-  ● Never leave the appliance unattended during operation.
- Do not use the appliance for any purpose other than those described in these instructions.
- Do not touch the hot parts (such as the spout etc) immediately while appliance is in use or after use.
 - The accessible parts may become hot during use. Be careful with the residual heat source especially after use.
- Do not pour hot water or move the appliance while the water is boiling.
- Do not use the appliance on following places.
 - On uneven surfaces, on carpet, non-water-resistant surface or tablecloths etc.
 - Places where it may be splashed with water or near a heat source.
 - Near any open water sources such as sinks, or the like.

CAUTION

To avoid risk of electric shock, fire, burn, injury or property damage.

-  ● Do not use the appliance near a wall, furniture, or in enclosed spaces such as a built-in cupboard. (It may cause discoloration or deformation.)
- Make sure to hold the power plug when unplugging the power plug. Never pull on the power cord.
-  ● Always ensure the appliance is switched off and unplug the power plug from outlet when the appliance is not in use, before moving and cleaning.
- Place the appliance on a firm dry, clean flat heatproof worktop.
- Beware not to tripped over or get caught in the power cord while in use.
- Do not open the lid while the water is boiling and immediately after use. When opening the lid, steam and hot liquid may spurt out or drop on your hand.
- Pour out any remaining hot water from the spout.
- The appliance is only to be used with the stand provided. Do not use power source other than the dedicated power base, or use the power base with any other equipment.
- Unplug and allow the appliance cool down before moving, cleaning and storing away.
- Beware when pouring hot water. Pour slowly, and do not over-tilt the appliance.
- Remove the appliance from its stand before filling or pouring.
- Do not touch the appliance with wet hands.
- Do not press down the power switch except boiling water.
- When carrying the appliance, make sure lid has been set firmly.

Important Information

- Do not drop the body or power base to avoid damaging it.
- Do not move the body or power base by dragging.
(It may scratch the table or work surface.)
- Do not turn the power switch on without water.
(It may cause malfunction.)
- Do not use the appliance outdoors.
- Make sure the appliance is properly located on the stand before switching on.
- Beware of steam when the appliance is refill with water immediately after boiled.
- Do not move the appliance by holding the lid.
- Make sure to clean the appliance after every use.



This symbol on the products indicates “hot surface and should not be touched without caution”.

Parts Names and Handling Instructions

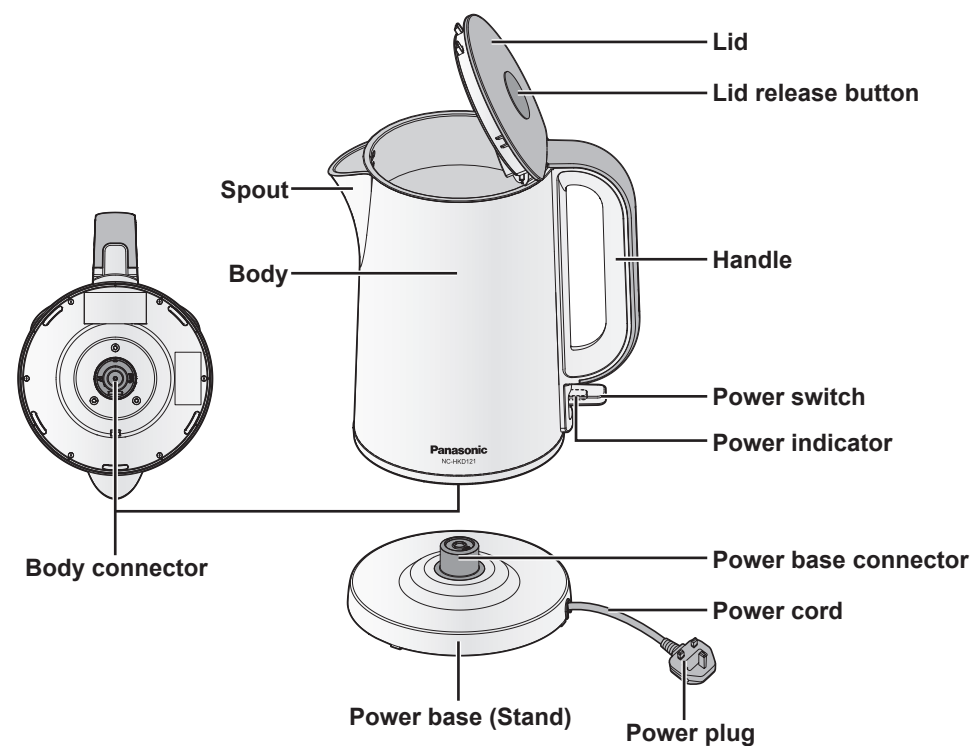

Before use

- Clean the appliance by following the steps below for the first time or when you have not used it for a while.
- ① Fill water up to the maximum water level and boil. (P. EN10)
- ② Pour the water out from the spout. (P. EN11 After use, pour out any remaining water.)
- Do not use a socket or extension cord.

How to Use

1 Open the lid and fill with water.

Opening the lid

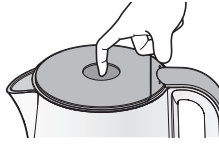

- Press the lid release button. (If the lid button is not pressed completely, the lid may not be opened.)



①

② Pour in water with another container!

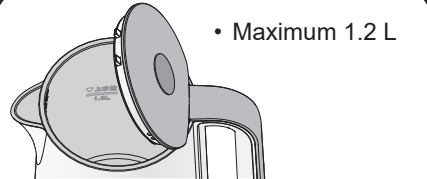

- Maximum 1.2 L

Adjusting the length of the power cord

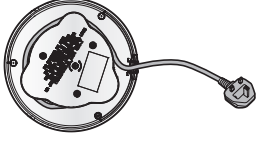

- * Wind the power cord on the bottom of the power base to adjust the length.

2 Close the lid, put the machine on the power base and insert the power plug.

Closing the lid

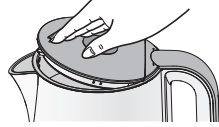

- Close the lid firmly as illustrated until you hear a click.

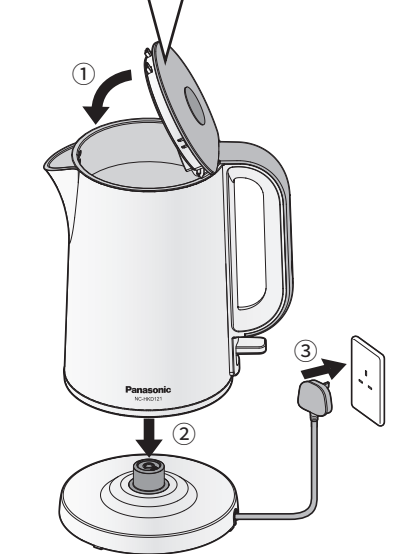

①

②

③

Note

- Do not insert the power plug before filling the water and closing the lid.

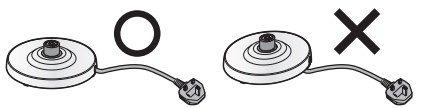

- * Pass the power cord out through the position of opening. (Do not put the power base on the power cord.)

3 Turn on the power switch. (Press to “|”)

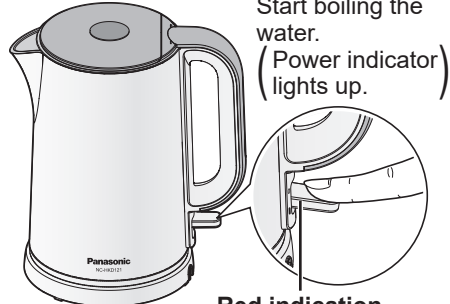

Start boiling the water. (Power indicator lights up.)

Red indication

During use, the power indicator lights up.

When the water has boiled, the power switch turns off automatically. (The machine takes around 5 minutes to boil. Water temperature 23 °C, room temperature 23 °C, water to max level, 220 V.)

- To stop boiling before the water has boiled, turn off the power switch.

Note

- Immediately after the water has boiled, do not force the machine to continue heating the water by keep pressing the power switch. (It may cause malfunction.)

4 Remove from the power base and pour.

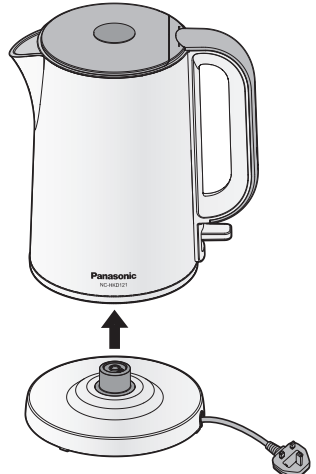

■ After use, pour out any remaining water.

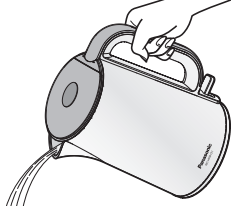

* Keep the lid closed when pouring away the water.

Empty-use prevention function

When the power switch is on without water, an empty-use prevention function works to automatically turn off the power in order to prevent accidents and malfunction due to overheating.

- ① Allow the body to cool sufficiently.
- ② Remove the body from the power base and fill the water.
- ③ Place it on the power base and turn on the power switch again.

* If you boil the machine without water, it may smell strange.

How to Clean

- Clean the appliance after every use.
- Before cleaning, be sure to disconnect the power plug from outlet, pour away the hot water, and cool down the body.

Note

- Do not use dish soap. (This may cause a residual odour.)
- Do not use benzine, thinner, alcohol, bleach, polishing powder, metal brush or nylon brush, otherwise the surface will be damaged.
- Do not wash in a dishwasher.
- Do not clean the appliance with pointed object such as a toothpick or pin.

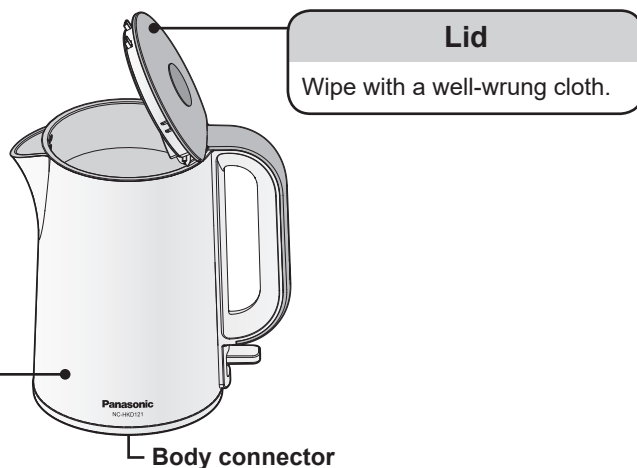

Lid
Wipe with a well-wrung cloth.

Body

(Outside)

Wipe with a well-wrung cloth.

(Inside)

Rub with a soft sponge and rinse.

Scale build-up

Minerals such as calcium carbonate contained in the water build up in the machine.

► Please remove the scale.

① Remove it regularly using:

- scale remover

Follow the instructions supplied with the scale remover.

- citric acid

Fill the machine with water half way up and boiled it. After switch is off, put approx. 80 g of citric acid and stir it well. Let it still for approx. 30 min.

- vinegar

Fill the machine with water up to Max level and boiled it. After switch is off, put approx. 100 mL of vinegar and stir it well. Let it still for approx. 2 hours.

② After removal, repeat the following steps a few times: fill with water, boil, pour away.

Power base

Wipe with a well-wrung cloth.

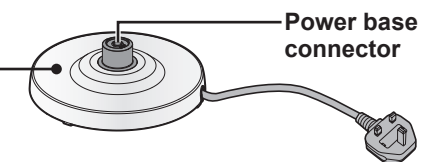

To store

- Dry it thoroughly.
- Put in a plastic bag and seal the bag to prevent insects etc. from entering.

English

Troubleshooting

Please check the following points before arranging for service.

Problem	Cause	and Action
Power switch does not turn on.	● Is the power plug plugged in?	● Insert the power plug into the outlet. (P. EN10)
	● Is the body set correctly on the power base?	● Ensure the body is set correctly.
	● Is there a piece of metal or foreign material adhered to the power base connector or body connector?	● Remove the piece of metal or foreign material. (P. EN12–13)
Water does not boil.	● Once the machine has boiled, the power switch is automatically turned off and cannot be turned on for approximately 3 minutes.	
	● Did you try to turn on the power switch without water in the machine? (The Empty-use prevention function will work to turn off the power switch.)	● Fill with water and turn on the power switch. (P. EN10)
	● Is the power switch turned off?	● Press to "I", and turn on the power switch. (P. EN11)

Troubleshooting

Problem	Cause	and Action
Hot water may burst out from the spout.	● Is the water level above the maximum water level?	● Reduce the water down to the maximum water level or lower. (P. EN10)
Water is dripping from the bottom of the body.	● Since the machine is designed to sense steam and turn off the power switch, the steam can condense and drip from the bottom of the body as water droplets. This is not malfunction.	
The hot water has a strange smell.	● Depending on the amount of chloride contained in the water supply, there may be a residual chalky smell.	
Shiny white or brown substances are floating in the hot water.	● This is scale. Scale is more likely to be generated when using water with a high mineral content.	● Clean the machine with a scale remover. (P. EN12)
Rough milky white substances are adhered to parts inside the body.	<ul style="list-style-type: none"> • Mineral water. • Water from ionic water purifiers. 	
The sound of water boiling has become very loud.	● The sound grows larger as scale adheres.	
A clicking sound is heard a short time after use.	● This sound is made when an internal heat component cools down. This is not malfunction.	
The machine is taking a long time to boil.	● Did you boil with the lid open?	● Close the lid. (P. EN10)
	● Scale build up.	● Clean the machine with a scale remover. (P. EN12)
	● If the water is very cold, the machine will take longer time to boil.	

Specifications

		NC-HKD121
Power supply		220 V ~ 50 Hz
Power consumption		1850 W
Dimensions (W × D × H) (approx.)	Body	21.5 cm × 15.0 cm × 23.2 cm
	Body + Power base	21.5 cm × 15.8 cm × 25.1 cm
Mass (approx.)	Body	0.9 kg
	Body + Power base	1.2 kg
Rated capacity		1.2 L
Length of the power cord (approx.)		0.7 m

- In certain regions (high altitude, very cold locations), it may not be possible to obtain the predetermined performance.

非常感謝您購買 Panasonic 的產品。

- 本產品僅供家庭使用。
- 本產品僅供煲水用，並不具備保溫功能。
- 請仔細閱讀本使用說明書，以確保正確安全地使用本產品。
- 使用本產品前請務必仔細閱讀「**安全注意事項**」和「**重要資訊**」（第 TC3–TC8 頁）。
- 請保存好本使用說明書，以備將來使用。
- 如對本產品不當使用或無法遵守相關說明，Panasonic 將概不負責。

目錄	頁碼
安全注意事項	TC3
重要資訊	TC8
部件名稱和操作說明	TC9
使用方法	TC10
清潔方法	TC12
疑難排解	TC13
規格	TC15

安全注意事項

請務必遵守說明

為了避免危害使用者及給他人造成財產損失，特此說明下列務必遵守的事項。

■ 下表列出因操作不當爾導致的損壞程度。

 **警告：** 表示有可能導致重傷或死亡的潛在危險。

 **注意：** 表示有可能導致輕傷或財產損失的潛在危險。

■ 針對務必需要遵守的事項，用以下符號予以區分說明。

 表示必須禁止的事項。

 表示必須執行的事項。

警告

為了避免觸電、因短路造成的火災、出煙、燒傷或受傷的風險。

 ● 請勿自行拆開、維修或改裝本產品。
→ 請向購買地點或 Panasonic 服務中心查詢。

● 切勿損壞電源線或電源插頭。

嚴禁進行下列操作：
損傷、加工或將其放置在加熱器附近，強行彎曲、扭轉、拉扯、從尖銳邊沿拉過電源線，在電源線上放置重物，捆扎電源線以及使用電源線提拉本產品。



● 電源線或電源插頭已損壞，或電源插頭未能穩妥的连接到家用電源插座，請勿使用本產品。

→ 如電源線損壞，必須由製造商、製造商的服務代理商或有同等資格的人員更換，以避免產生危險。

安全注意事項

請務必遵守說明

警告

為了避免觸電、因短路造成的火災、出煙、燒傷或受傷的風險。

- 切勿濕手插上或拔下電源插頭。
- 切勿將本產品（包括電源底座和電源底座接頭）、電源線和電源插頭浸入水中或用水及其他液體濺濕。
 - 從水龍頭直接為本產品加水或將本產品放進水槽時，切勿弄濕本產品的底部。
- 切勿讓電源線懸掛在桌子或工作檯邊緣或接觸高溫表面。
- 切勿讓嬰兒和兒童將包裝材料當作玩具。
(否則可能會導致窒息。)
- 切勿讓異物（尤其是萬字夾和電源線等金屬部件或者灰塵）黏附在壺身接頭或電源底座接頭上。
- 煲水時或煲水後，切勿觸摸壺嘴或讓臉部靠近壺嘴。
 - 尤其是不要讓嬰兒或兒童接觸本產品。
- 切勿用布料等物件堵塞壺嘴。
- 切勿用力關閉蓋子。
- 本產品僅用於煲水。除了水以外，切勿加入其他物質。
- 切勿搖晃或翻轉壺身。
- 切勿用於存放冰塊。
- 切勿將壺身放在任何熱源上或放入微波爐。
- 切勿舔電源底座接頭。
 - 嬰兒和兒童在本產品附近時，要注意安全。
- 煲水務必蓋緊蓋子。

警告

為了避免觸電、因短路造成的火災、出煙、燒傷或受傷的風險。

- 本產品不打算由兒童或有體力、感官或精神缺陷的人或缺乏經驗知識的人使用，除非有負責他們安全的人對他們進行產品使用有關的監督和指導。
請監督兒童，確保不讓他們把本產品當作玩具。
- 切勿讓嬰兒和兒童接觸本產品，包括電源線。
- 應插緊電源插頭。
- 定期清除電源插頭上的灰塵。
→ 拔下電源插頭，用乾布擦拭。
- 若本產品發生運作異常時，請立即停止使用本產品，並拔下電源插頭。
異常或故障事例：
 - 電源插頭和電源線異常發熱。
 - 電源線損壞或本產品無法通電。
 - 本體變形、有明顯損壞或異常發熱。
 - 壺身漏水。
 - 煲水時蒸氣持續冒出超過3分鐘。
 - 有其他異常情況或故障。→ 立即拔下電源插頭，並聯絡客戶服務人員進行檢查或維修。
- 請務必確保本產品標籤上規定的電壓與您的本地電壓一致。並避免將其他裝置的插頭插入同一個插座，以防止發電過熱。但如果連接了多個電源插頭，請確保總功耗不超過插座的額定功耗。
- 倒入的水切勿超過上水位（最高水位）指示線，如果本產品裝水太多，沸騰時水可能會噴出造成燙傷等危險發生。

安全注意事項

請務必遵守說明

⚠ 注意

為了避免出現觸電、火災、燙傷、受傷或財產損失的風險。

- 本產品煲水時，請勿離開。
- 除了本說明書描述的用途以外，切勿將本產品用於其他用途。
- 煲水時或煲水後，請勿立即觸摸高溫部件（例如壺嘴）。
 - 煲水時，觸摸得到的部件可能會變熱。
 - 煲水後應小心熱源的餘熱。
- 煲水期間，切勿倒出熱水或移動本產品。
- 切勿在下列場所使用本產品。
 - 不平坦的表面、地毯、不防水的表面或桌布等。
 - 容易被水濺到或靠近熱源的地方。
 - 靠近水槽等開放水源的地方。
- 切勿靠近牆壁、家具或在內置式碗櫃等封閉空間裏使用本產品。（否則可能會導致家具變色或變形。）
- 拔下電源插頭時必須握緊電源插頭。切勿拉扯電源線。

⚠ 注意

為了避免出現觸電、火災、燙傷、受傷或財產損失的風險。

- 不使用本產品時、移動或清潔之前，務必確保電源已經關閉及電源插頭已經拔下。
- 將本產品放在一個堅固乾燥、乾淨、平坦耐熱的工作枱上。
- 煲水時，注意不要被電源線絆倒或纏繞。
- 水沸騰時切勿打開蓋子，煲水後也不要立即打開蓋子。打開蓋子時，蒸氣和熱水可能會噴出或滴落到手上。
- 從壺嘴倒出剩餘的所有熱水。
- 本產品只能與隨附提供的電源底座一起使用。切勿使用專用電源底座以外的電源或將電源底座用於其他任何設備。並不得以外部開關供電。
- 在移動、清潔和存放本產品之前，拔下插頭，讓本產品冷卻。
- 倒熱水時要小心。慢慢倒水，壺身不要過度傾斜。
- 在加水或倒水之前，將本產品與電源底座分離。
- 切勿濕手觸摸本產品。
- 除了煲水以外，切勿按下電源開關。
- 拿著本產品時，請確認蓋子已完全關閉。

重要資訊

- 切勿讓壺身和電源底座跌落，以避免發生損壞。
- 切勿以拖扯方式移動壺身和電源底座。
(否則可能會刮花桌子或工作枱。)
- 壺裡沒有水時切勿開啟電源開關。
(否則可能會導致發生故障。)
- 切勿於戶外使用本產品。
- 開啟電源開關之前，確保本產品正確放置在底座上。
- 水沸騰後重新給本產品加水時，小心蒸氣。
- 切勿手持蓋子移動本產品。
- 每次使用後務必清潔本產品。



此符號表示：產品表面高溫，觸摸時請小心謹慎。

部件名稱和操作說明

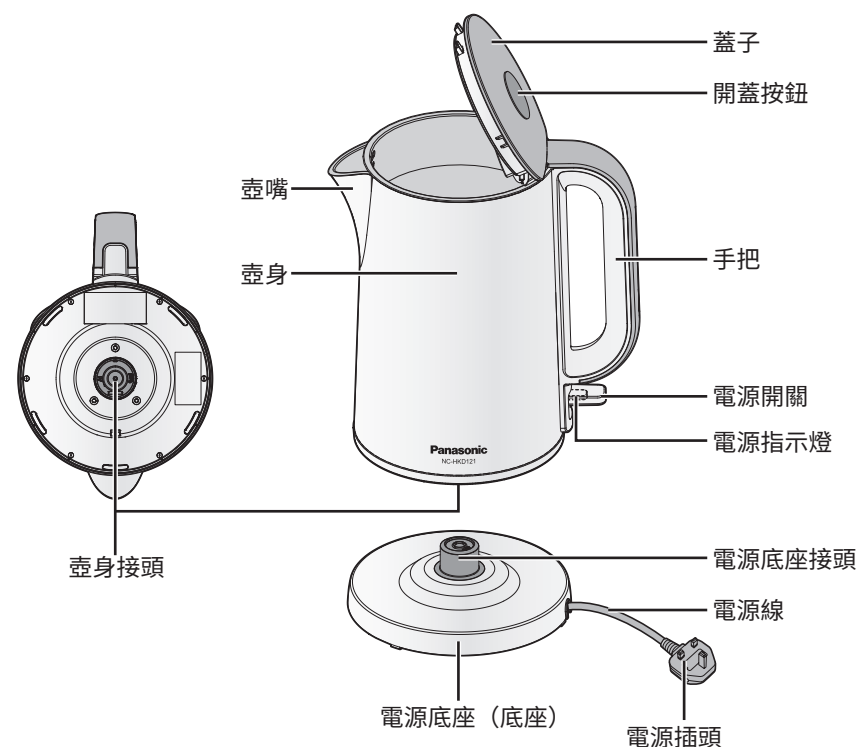

使用前

- 首次清潔或有一段時間未使用本產品時，請遵循下列步驟清洗本產品。
 - ① 加水至最高水位並煲水。(第 TC10 頁)
 - ② 從壺嘴將水倒出。(第 TC11 頁，使用後，倒出所有剩餘的水。)
- 切勿使用拖板或延長線。

使用方法

1 打開蓋子加水。

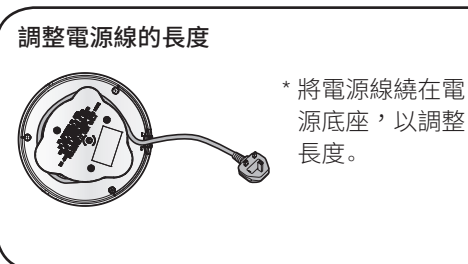
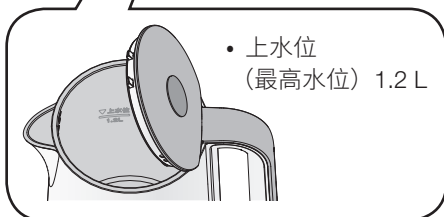
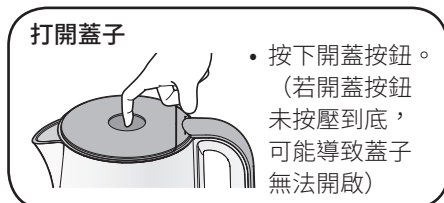

2 合上蓋子，將壺身放在電源底座上，插入電源插頭。

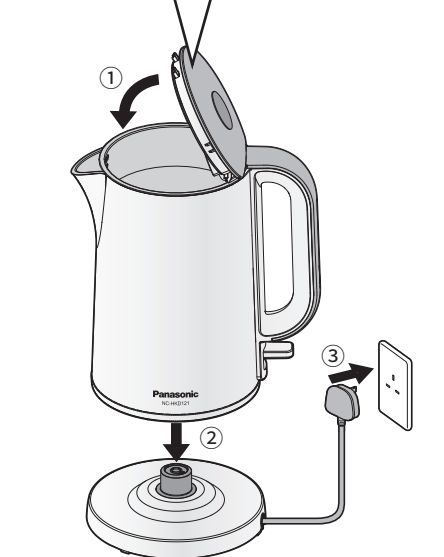
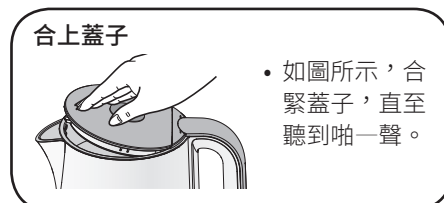

備註

- 在加水和合上蓋子之前，切勿插入電源插頭。

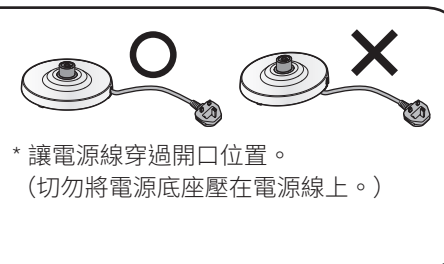

清潔方法

- 每次煲水後請清潔本產品。
- 清潔前，請務必將電源插頭從插座上拔下，倒出壺裡的水，並讓壺身冷卻。

備註

- 切勿使用洗潔精。（否則可能會導致氣味殘留。）
- 切勿使用苯、稀釋劑、酒精、漂白劑、拋光粉、金屬刷或尼龍刷，否則本產品表面會受損。
- 切勿用洗碗機清洗。
- 切勿用牙籤或萬字夾等尖銳物體清潔本產品。

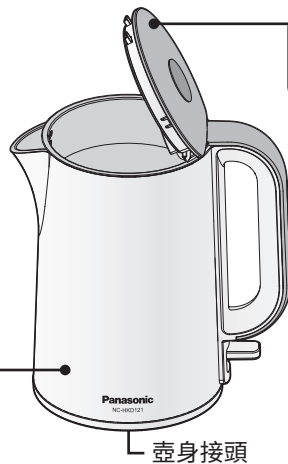

蓋子

用擰乾的布擦拭。

壺身

(外部) 用擰乾的布擦拭。
 (內部) 用柔軟的海綿擦洗，然後沖淨。

水垢積聚

水中含有的碳酸鈣等礦物質會在電熱水壺裡越積越多。

▶ 請清除水垢。

① 使用下列方法定期清除水垢：

- **除垢劑**
按照除垢劑提供的說明進行操作。
- **檸檬酸**
往壺裡加一半的水，將水煲滾。電源開關自動關閉後，放入約 80 克檸檬酸，並充分攪拌。靜置大約 30 分鐘。
- **醋**
往壺裡加水至最高水位，將水煲滾。電源開關自動關閉後，放入約 100 毫升醋，並充分攪拌。靜置大約 2 小時。

② 清除水垢後，重複下列步驟數次：加滿水，煲滾，將水倒掉。

電源底座

用擰乾的布擦拭。

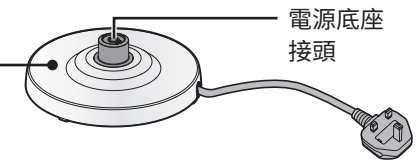

如何存放

- 讓本產品徹底乾透。
- 將本產品放進膠袋，將袋子密封，防止昆蟲等進入。

疑難排解

請先閱讀下列要點，再安排維修。

問題	成因	解決方法
電源開關無法開啟。	● 電源插頭是否已經插入？	● 將電源插頭插入家用電源插座。（第 TC10 頁）
	● 壺身是否正確放在電源底座上？	● 確保壺身正確放置。
	● 電源底座接頭或壺身接頭是否黏有金屬或異物？	● 將金屬或異物清除。（第 TC12-TC13 頁）
	● 水煲滾後，電源開關會自動關閉，在大約 3 分鐘內不能再次開啟。	
水煲不滾。	● 您是否曾在壺裡沒有水的時候開啟電源開關？ (防止空燒功能會發揮作用，關閉電源開關。)	● 加水並開啟電源開關。（第 TC10 頁）
	● 電源開關是否已關閉？	● 按至「I」，開啟電源開關。（第 TC11 頁）

疑難排解

問題	成因	解決方法
熱水可能會從壺嘴噴出。	● 水位是否高於最高水位線？	● 將水位降低至最高水位線或以下。(第 TC10 頁)
水從壺身底部滴下。	● 由於電熱水壺能夠自動感應蒸氣和關閉電源開關，因此蒸氣會凝結成水滴，從壺身底部滴下。這不是故障。	
熱水有異味。	● 視乎供水系統中的含氯量，水裡可能會含有殘留異味。	
熱水中有閃亮白色或啡色物質漂浮。	● 這是水垢。 如果使用的水中的礦物質含量高，就更容易產生水垢。	● 用除垢劑清潔電熱水壺。(第 TC12 頁)
壺身內部黏附有粗糙的乳白色物質。	● 礦泉水。 ● 來自離子淨水器的水。	
水沸騰的聲音變得非常大。	● 隨著水垢越積越多，水沸騰的聲音會變得越來越大。	
煲水後短時間內會聽到一次啪一聲。	● 聲音是內部的加熱部件冷卻後發出的。這不是故障。	
電熱水壺需要很長時間才能將水煲滾。	● 您煲水時，蓋子是否開著？	● 合上蓋子。(第 TC10 頁)
	● 水垢堆積。	● 用除垢劑清潔電熱水壺。(第 TC12 頁)
	● 如果水溫很低，電熱水壺就需要更長時間才能將水煲滾。	

規格

		NC-HKD121
電源		220 V ~ 50 Hz
功耗		1850 W
尺寸 (寬度 × 深度 × 高度) (約)	壺身	21.5 cm × 15.0 cm × 23.2 cm
	壺身 + 電源底座	21.5 cm × 15.8 cm × 25.1 cm
重量 (約)	壺身	0.9 kg
	壺身 + 電源底座	1.2 kg
額定容量		1.2 L
電源線長度 (約)		0.7 m

- 在某些地區 (海拔高、非常寒冷的地方)，本產品可能無法發揮預設的性能。



Memo



Memo

