

Panasonic®

Operating & Installation Instructions

Washing Machine
(Household Use)

Model No.
NA-120VX7



Contents

SAFETY PRECAUTIONS	4
Before Using	8
Washing	14
Optional Functions	22
Maintenance	27
Troubleshooting	30
Installation / Others	34

Thank you for purchasing this product.

- Read these instructions carefully for optimum performance and safety before use.
- Keep this manual for future reference.



AWW9901A5MA0-0B0

Contents

SAFETY PRECAUTIONS	■ Safety Precautions	4
--------------------	--------------------------------	---

Before Using	■ Checking Your Washing Machine	8
	■ Before Washing	9
	■ Control Panel	10
	■ Detergent	12

Washing	■ Washing (Basic Method)	14
	■ Programme List	16
	■ Details of Programmes	18
	■ Washing Tips	20

Optional Functions	■ Changing Programme Settings	22
	• Changing the temperature [↓ Water Temp]	22
	• Changing the water level [Water Level]	22
	• Changing the spin speed [⊕ Spin Speed]	23
	• Setting the programme end time [⏸ Preset]	23
	■ Washing with Optional Functions	24
	• Select and run processes [Mode]	24
	• Prewash [↓ Prewash]	24
	• Rinse thoroughly [Extra Rinse]	25
	• Sterilise the laundry [Blue Ag+ (Max. 3 kg)].	25

■ Changing Appliance Settings	26
• Cancelling the buzzer	26
• Setting the Child Lock [Child Lock]	26
• Cancelling the “Active Foam” function	26

Maintenance

■ Maintenance	27
• Water supply filter	27
• If the water supply hose is frozen	27
• Appliance	28
• Drum	28
• Detergent drawer	28
• Drain filter	29

Troubleshooting

■ Troubleshooting	30
■ Error Display	33

Installation / Others (Ask the installation to service person)

■ Choosing the Right Location . . .	34
■ Moving and Installing	35
■ Connecting the Hoses	37
■ Checking after Installation	39
■ Power and Water Consumption	41
■ Specifications	42

Safety Precautions

Read and follow these safety precautions.



May cause serious injury or death.

For the safety of you and your family

- This appliance is not intended for use by persons (including children) with reduced physical, sensory or mental capabilities, or lack of experience and knowledge, unless they have been given supervision or instruction concerning use of the appliance by a person responsible for their safety.
- Children should be supervised to ensure that they do not play with the appliance.
- Keep away from fire. Do not put flammable materials or clothes with such things attached in the drum. Keep them away from the appliance. (To prevent explosion or fire)
For example: Kerosene, gasoline, benzine/thinner, alcohol, etc.
- To prevent injury, do not touch the drum until it completely stops.

Ground the appliance

- Be sure to have your dealer perform grounding work. If not provided a ground, electric shock may occur in electric leakage



WARNING

To prevent electric shock, overheating, combustion, or fire

- Use a socket that satisfies the rating requirement solely for this appliance. Do not use a plug adaptor or extension cord.
- Do not use a power cord or plug that is damaged. If the power cord is damaged, it must be replaced by the manufacturer, its service agent or similarly qualified persons in order to avoid a hazard.
- Do not plug in or unplug the power cord with wet hands.
- Always fully insert the power plug into the socket.
- Do not hold or pull on the cord when removing the plug from the socket.
- Unplug the power cord before cleaning.

Repairs

- Never disassemble, repair or modify the appliance yourself.
In case of malfunction or failure, immediately stop use, unplug the power cord, and ask your nearest service centre for repair.

Safety Precautions (continued)

CAUTION

May cause injury or property damage.

Correct use

- This appliance is only suitable for textiles labelled washing machine washable.
- Do not connect to a hot water supply.
- Do not obstruct the openings of the bottom face with carpet, etc.

To prevent water leaks

- New hose-sets supplied with the appliance are to be used and old hose-sets should not be reused.
- Turn off the tap if the appliance is not going to be used for a prolonged period, such as during a holiday. Water could leak while you are away and cause damage to household goods.

To prevent injury and burns

- Keep your fingers away from the door hinge when opening and closing the door.
- Do not climb onto the appliance.

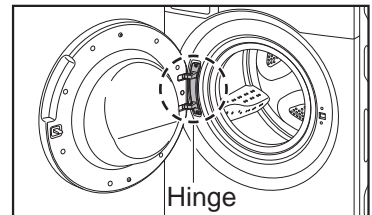



CAUTION

- When washing at high temperature, be careful not to burn yourself. Drain hose, drum, door glass, and laundry will be hot.

To prevent damage to the appliance and laundry

- Do not operate the appliance with the anchor bolts still fitted. This may cause excessive vibration of the appliance.
- Do not wash clothes that are stained with a lot of vegetable oil, cosmetic oil, etc. The oil can get hot and deform the door seal, leading to water leakage.
- Do not wash, rinse, or spin waterproof sheets or clothes. Intense vibration during spin or falling of the appliance may result in injury, damage to the main unit, wall, floor, laundry, or water leakage.
For example: Raincoats, wet suits, etc.

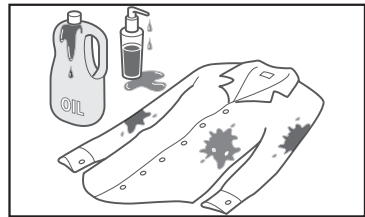

Checking Your Washing Machine

Detergent drawer (P. 12)

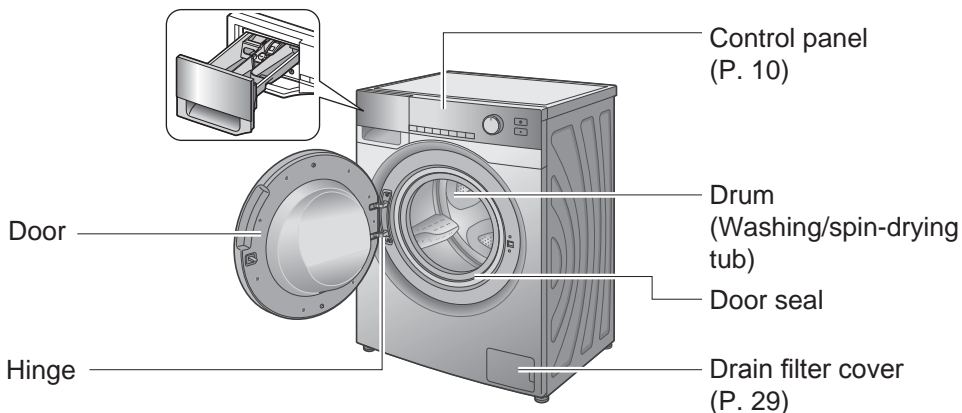

(Rear of appliance)

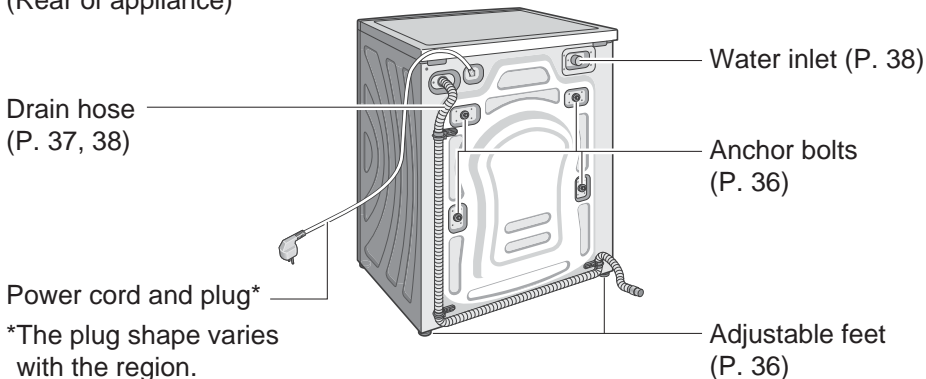

Accessories

Elbow (P. 38)



Water supply hose (P. 37, 38)



Cover caps (4) (P. 36)



Bottom plate (P. 35)

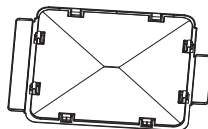

Before Washing

Check before use

When first using or after a long time of idling, check the following.

- The water supply hose and drain hose are connected properly. (P. 37, 38)
- There is no problem in the water supply hose connection, when turning on the tap.
- The power plug is plugged in.

Before first use

There may be drops of water, or condensation, in the appliance due to the factory inspection process before shipment. To rinse away any residues etc., operate as follows:

- "Cotton" programme
- Default setting 40 °C
- No detergent, no clothing

Preparing laundry

Read the washing labels of clothes, and sort them by colour, fabric, and degree of soiling. This helps you choose a suitable programme and temperature.

■ Stained items

- Apply stain remover to any stains.
- "StainMaster+" programmes (P. 17) are recommended for removing stains.

■ Sorting

- Wash separately clothes that are not colour fast. (denim, dark coloured items, etc.)

■ Before putting clothes in drum

To prevent damaging clothes or malfunctioning of the appliance, carry out the following steps.

- Remove foreign objects (coins, pins, clips, nails) from laundry.

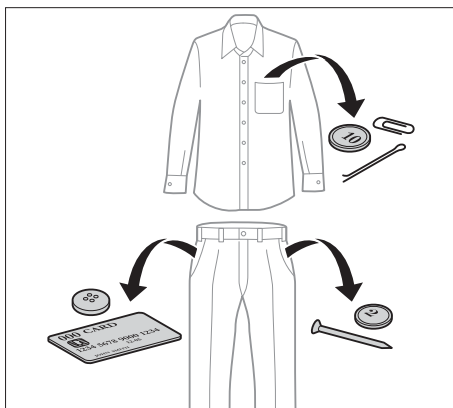

- Tie strings on aprons, etc.
- Clothing with raised fabric: Turn inside out.
- Clothing with zippers: Pull up zippers, and turn inside out.
- Small items, wired bras, and lace items: Put in a laundry net.

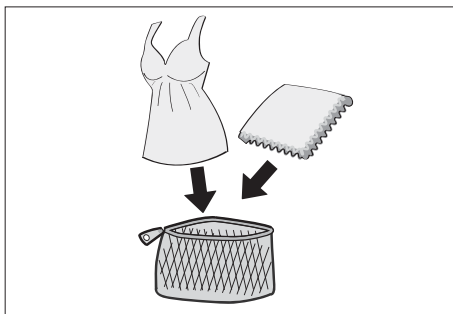

- Brush off hair, animal fur, sand etc. before washing
- Heavy dirt or deep stains: Wash lightly by hand first.

Control Panel

Controls

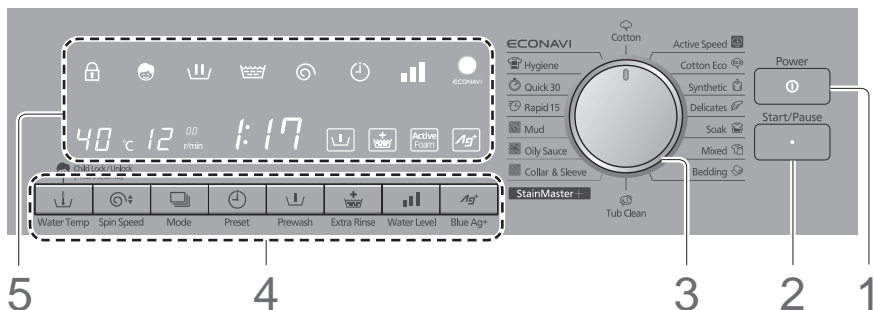

1. Power button [Power

2. Start/Pause button [Start/Pause]









To start or pause the operation.

3. Programme selection dial

Use this dial to choose a programme suitable for the laundry. (P. 16)

4. Control buttons

To change washing settings or to select optional functions.

	Water temperature (P. 22)
	Child Lock*1 (P. 26)
	Spin speed (P. 23)
	Mode (P. 24)
	Preset (P. 23)
	Prewash (P. 24)
	Extra Rinse (P. 25)
	Water Level (P. 22)
	Blue Ag+ (P. 25)

5. Display (P. 11)

*1 Child Lock: Press and hold the button for at least 5 seconds to lock the door and other buttons.

NOTE

- To turn the power off and back on, press “Power” to switch off and make sure the display has gone off, before turning back on.

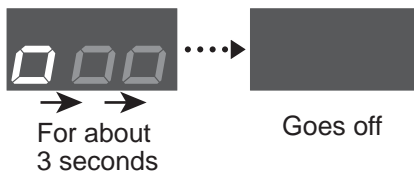

- If you do not press “Start/Pause” within 10 minutes of powering on the unit, the appliance automatically switches itself off.

Display

This illustration shows all indications for explanation purposes.

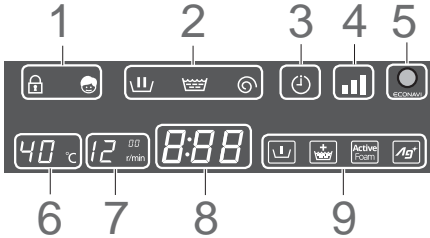

1. Lock

: The door is locked

: The door and buttons are all locked (Child Lock)

2. Process

Each indicator flashes to show the current process, and goes off when the process finishes.

	wash
	rinse
	spin

3. Preset

(P. 23)

4. Water level

5. ECONAVI lamp

Lights up while the “ECONAVI” programme is selected. Flashes during the ECONAVI detection. (P. 21)

6. Water temperature

7. Spin speed

8. Remaining time

This indicator shows the approximate time until the operation finishes.

Error display

An error is displayed if the appliance malfunctions. (P. 33)

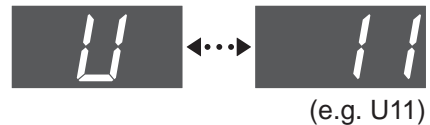

9. Optional functions

Selected optional functions are displayed. (P. 24, 25)

NOTE

- In case of a power failure during operation, the appliance resumes the process from the interrupted point after the power comes back. (Auto Restart)

Detergent

- Add detergent, etc. before pressing “Start/Pause”.
- Read instructions on the packet of detergent or other agent, for correct quantity depending on the amount of laundry, degree of soiling, and water hardness.

Detergent, water softener, bleach, stain remover

- When using a tub cleaning detergent, also put it in this compartment. (P. 28)

Fabric softener

It's automatically added to laundry during final rinsing.

- Do not let it exceed “MAX” (130 ml) line.

Foam generator

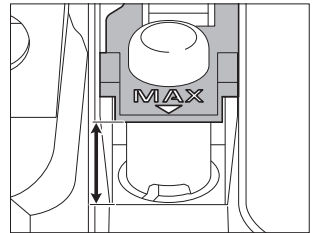

Detergent for prewashing

When using “Prewash” function (P. 24)

Detergent drawer

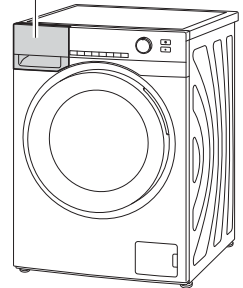
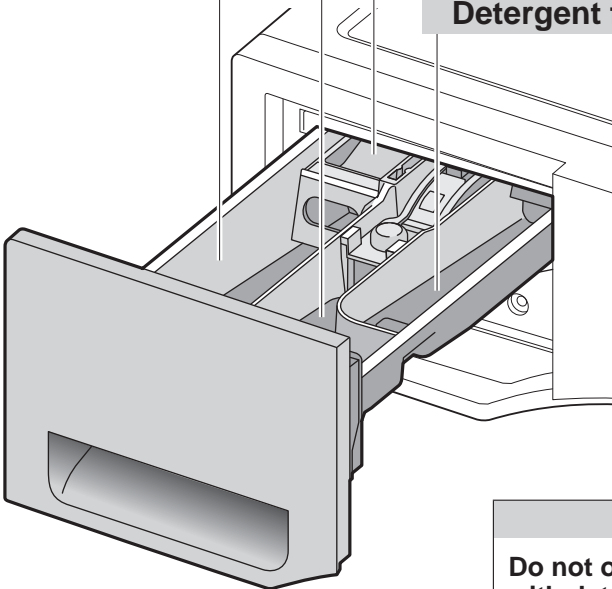

CAUTION

Do not operate this appliance with detergent drawer detached.
It will leak water.

Detergent

Use a low foam detergent.

- To prevent powdered detergent from remaining in detergent drawer:
 - Dry inside the detergent drawer with a cloth.
 - Break up lumps in powdered detergent.

If powder still remains in drawer, put it directly in drum instead.

- If you forget to add detergent before starting a wash, drain water out of the drum and start again.

NOTE

- **Do not put detergent in the detergent drawer, if the instructions on the package advise that it should be put directly in the drum.**

The detergent may not flow freely, and some may remain in the drawer, causing water to overflow from the drawer.

- **Do not put detergent in the foam generator.**

■ Prewashing

- You need separate detergent for prewash and main wash.
- Use powdered detergent for main wash. Liquid detergent washes away in prewash.

Water softening agent

If you live in a hard water area (1.3 mmol/L hardness or more), we recommend using a water softening agent. This reduces the detergent required, and prevents limescale, which damages the appliance.

NOTE

- For information on water hardness, contact a specialist near you.

Fabric softener

Prevents laundry static.

- If any softener remains in detergent drawer after operation, dilute the softener with water before pouring into the drawer. (do not exceed the max amount)
Softener left in drawer: You can wipe it with a wet cloth.

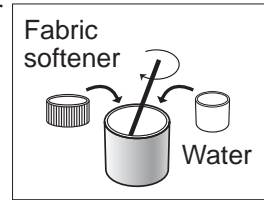

Washing Basic Method

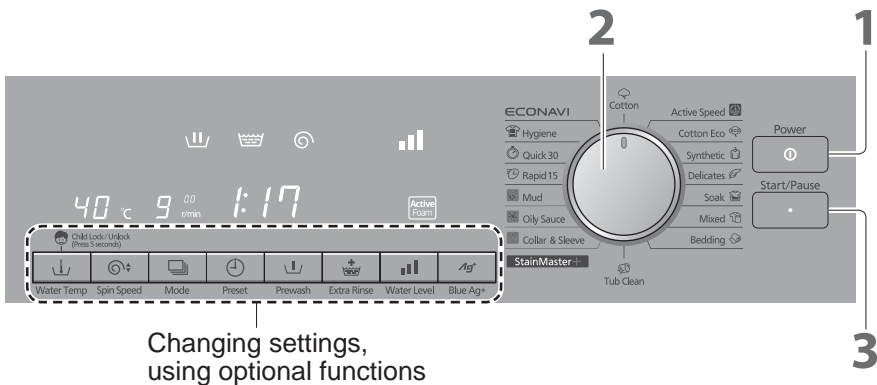

NOTE

- **Do not get laundry caught in the door.**
It can cause damage to the door seal.

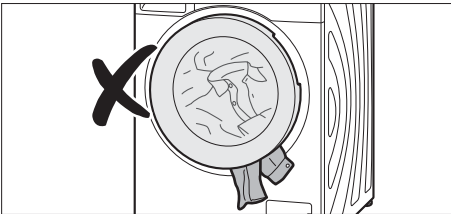

- **Do not put too much laundry into the drum.**
It can cause excessive vibration or damage to the appliance.

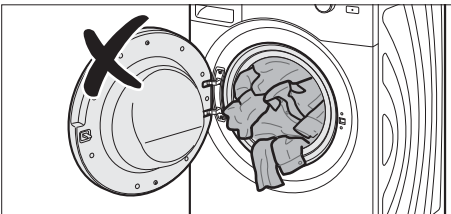

■ To open the door during operation

(The door is locked during operation)

Start/Pause **Press “Pause”.**
(The lock is released with a click)

- During spinning process, it may take about 1 minute for the drum to stop rotating.

■ Preparing

- Sort the laundry and put it into the drum. (P. 9)
- Add the detergent. (P. 12)

1  **Turn on the power.**

2  **Select a programme.**
(P. 16, 17)

The required time is displayed.

■ Changing settings

■ Using optional functions

3  **Start operation.**

- Weighing (about 30 seconds)

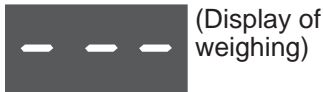

Some programmes do not weigh the laundry.
(P. 16, 17)

- Required time display (recalculated)







Operation finishes.
(The buzzer sounds and the door lock is released.)

NOTE

- Colours can run between clothes, so remove coloured laundry soon after the programme finishes.





Changing settings

After selecting a programme, you can change the following settings.

-  Water temperature (P. 22)
-  Spin speed (P. 23)
-  Preset timer (P. 23)
-  Water level (P. 22)

Using optional functions







After selecting a programme, you can add the following optional functions.

-  Mode (P. 24)
(Select and run the wash, rinse or spin process)
-  Prewash (P. 24)
-  Extra Rinse (P. 25)
-  Blue Ag+ (P. 21, 25)

NOTE









- The range of settings you can change and the optional functions you can add vary depending on the programme. (P. 18)

Programme List

Programme	Description	Max load (kg)	Time* ¹
 Cotton	For daily items of cotton, linen and cotton blends, e.g. T-shirt, underwear, towel, and tablecloth.	10.0	0:57 - 1:17
 Cotton Eco	Takes longer but consumes less energy and water than the Cotton programme.	10.0	1:00 - 1:20
 Synthetic*²	Washes chemical fibres gently.	5.0	0:53
 Delicates*²	For underwear and machine-washable silk clothes.	2.0	0:41
 Soak	For heavily-soiled clothes.	5.0	1:47
 Mixed	For blended fabrics, e.g. cotton, linen, and synthetic fibres.	10.0	1:12 - 1:47
 Bedding*²	For large items such as blankets, curtains and bedspreads.	3.0	1:21

NOTE































- The required time varies depending on temperature, water pressure, drainage condition, and load size.

Programme	Description	Max load (kg)	Time* ¹	
ECONAVI	For items with mixed fabric, for example, cotton, linen and synthetic fibres. (For details, see page 21)	10.0	1:18 - 2:23	
 Active Speed	Washes faster than the Cotton programme with small load.	5.0	0:49	
 Quick 30*²	30 min. quick wash for lightly soiled cotton and linen blends.	5.0	0:30	
 Rapid 15*²	15 min. full rapid wash for a small amount of lightly soiled items.	2.0	0:15	
 Hygiene	Washes infants' clothing, tablecloths and sheets.	10.0	1:43 - 1:58	
 Tub Clean	Cleaning the drum.	No clothing	3:36	
StainMaster+ Suitable for removing stains.	 Mud	For mud stains.	10.0	2:27 - 3:12
	 Oily Sauce	For stains of oily sauce.	10.0	2:07 - 2:47
	 Collar & Sleeve	For collar and sleeve stains.	10.0	2:17 - 3:02

*1 For each programme's default water temperature.

*2 The load is not weighed after "Start/Pause" is pressed. Operation starts straight away.

Details of Programmes

Settings Programme	Auto setting			
	Water Temp (°C)*1	Water level*2	Spin speed (r/min)	Water Temp (°C)*1
 Cotton	40		900	Cold, 30, 40, 50, 60
 Cotton Eco	40		1200	Cold, 30, 40, 50, 60
 Synthetic	30		700	Cold, 30, 40
 Delicates	30		500	Cold, 30, 40
 Soak	40		900	Cold, 30, 40
 Mixed	40		1000	Cold, 30, 40
 Bedding	Cold		700	Cold, 30
ECONAVI	Cold		1000	Cold, 30, 40, 50, 60
 Active Speed	40		900	Cold, 30, 40
 Quick 30	Cold		900	Unchangeable
 Rapid 15	Cold		900	Unchangeable
 Hygiene	90		900	60, 90
 Tub Clean	40		900	Unchangeable
 Mud	40		900	Unchangeable
 Oily Sauce	40		900	Unchangeable
 Collar & Sleeve	40		900	Unchangeable

*1 When the “Cold” is selected, nothing is displayed on the temperature indication.

*2 H:  High, M:  Medium, L:  Low

*3 “Active Foam” works automatically with the specified programmes.

Setting range		Optional functions				
Water level* ²	Spin speed (r/min)	Mode	Prewash	Extra Rinse	Blue Ag+ (Max. 3 kg)	Active Foam* ³
H, M, L	500, 700, 900, 1000, 1200	✓	✓	✓	✓	✓
H, M, L	500, 700, 900, 1000, 1200	✓	✓	✓	✓	✓
H, M, L	500, 700, 900	✓	✓	✓	✓	✓
Unchangeable	Unchangeable	✓	–	✓	✓	–
H, M	500, 700, 900, 1000, 1200	✓	–	✓	✓	✓
H, M, L	500, 700, 900, 1000, 1200	✓	✓	✓	✓	✓
H, M	500, 700	✓	–	✓	✓	✓
Unchangeable	900, 1000, 1200	–	–	–	✓	✓
M, L	500, 700, 900, 1000, 1200	✓	–	–	✓	✓
H, M, L	500, 700, 900	✓	–	–	–	✓
H, M, L	500, 700, 900	–	–	–	–	✓
H, M, L	500, 700, 900	–	–	✓	✓	–
Unchangeable	Unchangeable	–	–	–	–	–
Unchangeable	500, 700, 900, 1000, 1200	✓	✓	✓	✓	✓
Unchangeable	500, 700, 900, 1000, 1200	✓	✓	✓	✓	✓
Unchangeable	500, 700, 900, 1000, 1200	✓	✓	✓	✓	✓

Washing Tips

“Delicates” programme

■ When washing

- Place items flat on top of each other inside the drum.
- To rinse fully, use the “Extra Rinse” function. (P. 25)

■ When drying

- Lay out wool and nylon items flat.
- Hang out white or light-coloured nylon items in the shade. (away from direct sunlight)
- Use hangers for shirts, blouses and trousers.

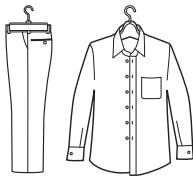



■ If items shrink in the wash

- 1 Spread the item to its original size on an ironing board.
- 2 Use dress pins to hold the size and shape.
- 3 Iron using a lot of steam and then leave the item to dry.



“Bedding” programme

■ Washable items

- Items with  (Wash) or  (Handwash) on label.
- Blankets, 100 % synthetic and 100 % cotton
- Sheets ● Bedspreads
- Undersheets, 100 % synthetic

NOTE

- You can only wash 1 item at a time.
- You cannot wash items made of wool, silk or long-pile fake fur.
- You cannot wash electric blankets.
- Do not use a laundry net. (It prevents drum rotation.)

■ Putting blankets into the drum

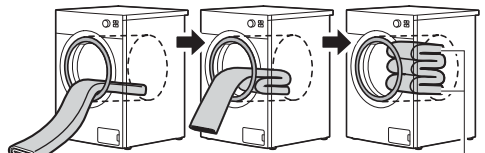
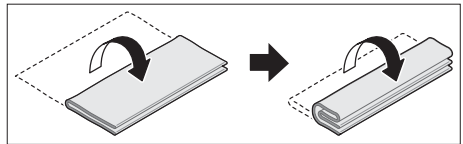

Both ends at the back of the drum

NOTE

- Do not roll blankets or bedspreads into balls or fold haphazardly. This may cause excessive vibration, damaging the appliance or laundry.

“ECONAVI” programme

This programme detects the water temperature, the laundry amount and material (cotton, chemical fibre, etc.), and determines the best suited wash time and water amount to save energy and water.

You can save time and energy more with smaller amount of laundry, or with larger amount of clothes that easily dry, such as chemical fibre, or with higher water temperature.

NOTE

- It is recommended that only dry items are put into the drum. If many wet items are loaded, ECONAVI sensing may not work properly.

“Blue Ag+” (Max. 3 kg)

This feature sterilises your laundry, which works during rinse using silver ions dissolving in the water and ultraviolet (UV) light.

NOTE

- Since the “Blue Ag+” is designed for laundry, do not use the water for other purposes, such as drinking or cooking.
- Kind of clothes, detergent, softener, and water hardness may affect the result.
- If there is allergy or abnormality after you wear the clothes sterilised by “Blue Ag+”, stop wearing the clothes.

- When the “Blue Ag+” is used with softener or liquid detergent, the laundry may turned yellow. If this occurs, wash them with powdered detergent without “Blue Ag+”. This whitens the yellowed clothes. (More effective with the water of 60 °C)

■ Replacing the Ag+ part

When the appliance is switched on and the Blue Ag+ lamp flashes, replace the internal Ag+ part to keep the sterilising effect.

The Blue Ag+ lamp, on the other hand, flashes during rinse to show the “Blue Ag+” sterilisation is working.

NOTE

- The “Blue Ag+” works for about three years if used twice a week with normal water conditions (water hardness, water amount and temperature).
- You can still use the washing machine after the Ag+ part’s service life, but no longer sterilising effect.
- Ask a service person for replacement.

“Active Foam”

The “Active Foam” works with the specified programmes as mentioned on page 19.

 lights up when the “Active Foam” is set and flashes while working.

Changing Programme Settings

■ Preparing

- Sort the laundry and put it into the drum. (P. 9)
- Add the detergent. (P. 12)

1  **Turn on the power.**

2  **Select a programme.**
(P. 16, 17)

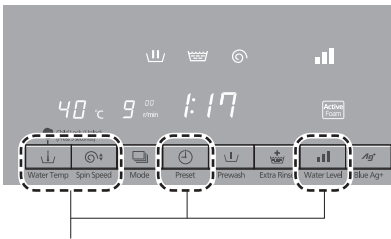

3 **Change settings of the programme.**

- The setting range depends on the programme.
(P. 18)

4  **Start operation.**

Changing the temperature

Water Temp

You can change the washing temperature according to the type of laundry or the degree of soiling.

3  **Press.**

Water Temp

The temperature indication displayed changes with each press.

■ Setting guide

- Higher temperature:
Whites, cottons, heavily soiled items
- Lower temperature:
Colours, items that shrink easily, lightly soiled items

Changing the water level

Water Level

You can change the washing water amount.

3  **Press.**

Water Level

The water level indication displayed changes with each press.

- : High (H)
- : Medium (M)
- : Low (L)

Changing the spin speed

Spin Speed

Change the spin speed to dry laundry more thoroughly or reduce wrinkles in laundry.

3



Spin Speed

Press.

The spin speed indication displayed changes with each press.

■ Setting guide

- Higher speed:
To dry more thoroughly
- Lower speed:
To reduce wrinkling

NOTE

- You can change the spin speed after the programme starts and until the wash process ends. Pause the programme and do the steps 3 and 4.

Setting the programme end time

Preset

You can set how many hours later the washing will end.

3



Preset

Press.

The time indication displayed changes with each press. Holding down “ Preset” changes the time continuously.

■ Setting range

Up to 24 hours (in increments of 1 hour)

■ To check a preset time



Preset

Press.

■ To cancel settings



Power

Turn off the power.

(All settings are cancelled)

NOTE

- Be sure to close the door and press “Start/Pause” to activate the “Preset”.
- Do not use a detergent that is difficult to dissolve because it may cake up before the wash starts and not flow into the drum.
- You cannot set the end time for the “Delicates” or “Tub Clean” programme.

Washing with Optional Functions

You can use combinations of optional functions with each programme.

■ Preparing

- Sort the laundry and put it into the drum. (P. 9)
- Add the detergent. (P. 12)

1  **Turn on the power.**

2  **Select a programme.**
(P. 16, 17)

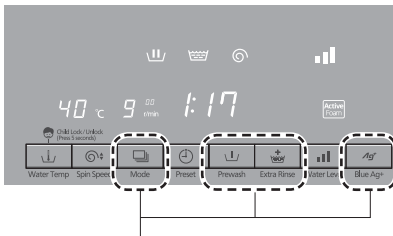

- 3** **Add optional function.**
- The options available differ depending on the programme. (P. 18)
 - An alarm sounds if you select an option that is unavailable.

4  **Start operation.**







Select and run processes



You can select and run a combination of wash, rinse and spin processes.

3  **Press.**
Mode

The indication displayed changes with each press.

 *2	Washes
 *1	Rinses
 *1	Spins
	Washes and rinses
 *1	Rinses and spins
	Washes and spins

*1 Drains first if there is water in the drum.

*2 Water will remain.

Prewash



You can wash laundry twice by adding the prewash option. This is good for heavily soiled items.

3  **Press.**
Prewash

 lights (activated) or goes out with each press.

Rinse thoroughly

Extra Rinse

If you are concerned that some detergent may remain in your laundry, you can add an extra rinse process.

3



Press.

Extra Rinse

 lights (activated) or goes out with each press.

NOTE

- You can change the “Extra Rinse” setting after the programme starts and until the wash process ends. Pause the programme and do the steps 3 and 4.

Sterilise the laundry

Blue Ag⁺ (Max. 3 kg)

Sterilises your laundry using silver ions and ultraviolet (UV) light. (P. 21)

3



Press.

Blue Ag⁺

 lights (activated) or goes out with each press.

NOTE

- If the “Blue Ag+” is set, the “Extra Rinse” function comes together.

Changing Appliance Settings

cancelling the buzzer

You can turn off the buzzer that sounds at the end of the programme.

1  **Turn on the power.**

2  **Press for at least 5 seconds.**
Prewash

The buzzer setting is cancelled after a beep.



■ To activate

Do the same operation as you did for cancelling. The buzzer setting is activated after two beeps.

Setting the Child Lock Child Lock

You can lock the door to prevent children from opening it themselves. This also locks the control buttons.

1  **Turn on the power.**

2  **Press for at least 5 seconds.**
Water Temp (  lights up.)

■ To deactivate

 **Press for at least 5 seconds.**
Water Temp (  disappears.)



- Ignore the beeps and keep pressing until the Child Lock is deactivated.



cancelling the “Active Foam” function

You can disable the “Active foam” function.

1  **Turn on the power.**

2  **Select “Tub Clean”.**

3  **Press for at least 3 seconds.**
Water Level (“002” is displayed and  lights up.)

4  **Press.**
Water Level (“002” is still on and  disappears.)

5  **Press.**
Start/Pause (The setting is complete and the power turns off)

■ To activate

Do the same operation as you did for cancelling.  lights up in step 4.

Maintenance

Water supply filter

Clean the filter if water is not supplied properly.



- 1 Turn off the tap.
- 2 Turn on the power and start the "Cotton" programme without any laundry or detergent inside the drum.
- 3 After 1 minute, turn off the power. Water has drained out of the water supply hose.
- 4 Remove the water supply hose and clean the water supply filter.

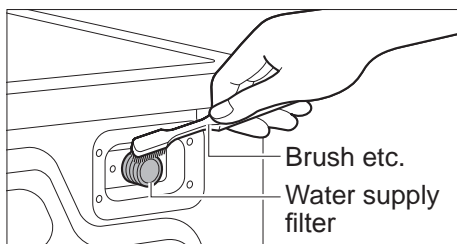

If the water supply hose is frozen

- 1 Wrap warm towels around the joints of the water supply hose.

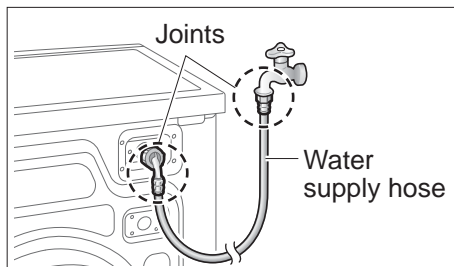

- 2 Put 2 to 3 litres of hot water (about 50 °C) into the drum.

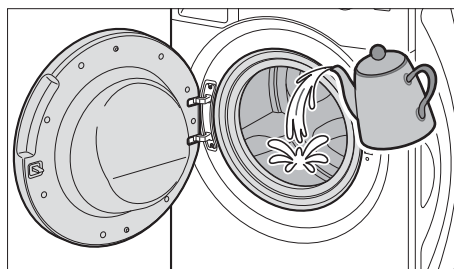

- 3 Wait for about 10 minutes, select and run the spin process in "Mode" function (P. 24).

Maintenance (continued)

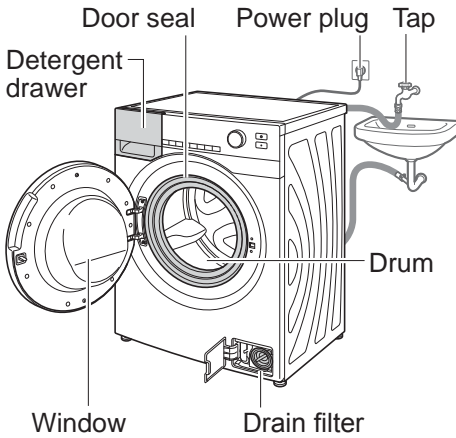

Appliance

Use a soft cloth to wipe off any water or dirt.

NOTE

- Do not splash water.
- Do not use gritty cleaners, thinners, nor products containing alcohol or paraffin oil.

■ Door seal and window

Wipe off any lint or foreign objects.

■ Appliance

Wipe with a cloth and mild kitchen detergent.

Drum

Once a month, run the “Tub Clean” programme with a Drum cleaning detergent commercially available. Follow the instructions of the Drum cleaning detergent.

NOTE

- If you use a scale remover, follow the manufacturer’s instructions.

Detergent drawer

Wash the detergent drawer with water. A build-up of detergent can develop mould.

- 1 Pull out the detergent drawer.

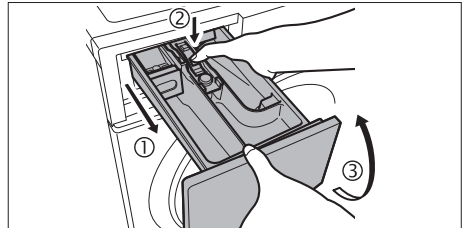

- 2 Pull laterally by both thumbs with proper force as shown by the small arrows in the figure, and push the softener cover upwards by the thumbs to remove it from the detergent drawer.

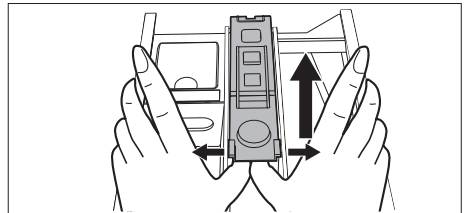

- 3 Wash the detergent drawer with water.
- 4 Replace the softener cover and detergent drawer.

Drain filter

Remove lint from the drain filter once a month. A build-up of lint can hamper drainage.

- 1 Switch off and unplug the appliance.
- 2 Open the drain filter cover on the front, and place a container to receive discharged water.

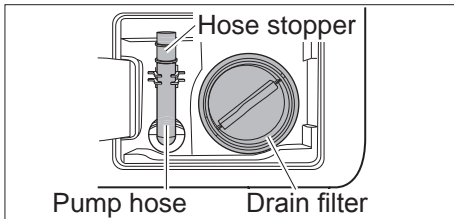

- 3 Pull out the pump hose, remove the hose stopper to drain water into the container.

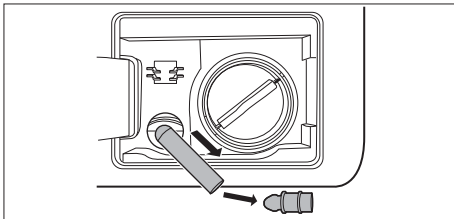

CAUTION

Do not remove the drain filter if there is water inside the drum, such as during operation. If you do, a large volume of water (possibly scalding water) will pour out.

- 4 No water being left, turn the drain filter anticlockwise to loosen and pull it out.

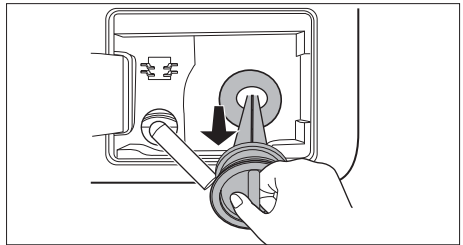
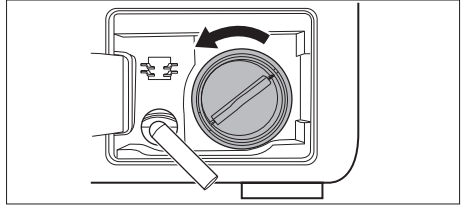

- 5 Remove any lint and debris.
- 6 Replace the drain filter.
- 7 Replace the hose stopper and pump hose and close the drain filter cover.

CAUTION

Be sure to turn the drain filter clockwise until it is in place. Otherwise, water leak may occur.

Troubleshooting





	Problem	Cause and Measures
Appliance	Buttons do not work	<ul style="list-style-type: none"> - Settings cannot be changed while an operation is in progress. Only the spin speed and “Extra Rinse” settings can be changed when the wash process is paused. - The Child Lock (🔒👤) may be activated. (P. 26)
	Door does not open	<ul style="list-style-type: none"> - The door is locked while an operation is in progress. (P. 14) - The Child Lock (🔒👤) may be activated. (P. 26) - The temperature inside the drum may be very high. - The water level may be too high. <ul style="list-style-type: none"> ■ To open the door immediately (1) Switch the appliance off and then on again. (2) Run the Spin operation (P. 24). After the water is drained and the temperature falls, you can open the door. - If you switch off the appliance or there is a power cut while the door is locked, it remains locked until the power is turned on again.
	Unusual odour	<ul style="list-style-type: none"> - Rubber parts may give off a smell when you first use the appliance, but the smell will go away over time. - Run the “Tub Clean” programme to clean the drum. (P. 28)
Wash	No water going into the appliance	<ul style="list-style-type: none"> - The tap may be turned off. - The water supply may be disrupted. - The water supply hose may be frozen. (P. 27) - The water supply filter may be blocked. (P. 27)
	Water builds up during a wash	<ul style="list-style-type: none"> - This is normal. Water is automatically supplied if the water level falls.
	Water drains out during a wash	<ul style="list-style-type: none"> - If there is excess foam, water is drained out and fresh water supplied to remove the foam. This is the foam detection function. - Even if water is directly supplied to the drum, it may drain away without building up.

	Problem	Cause and Measures
Rinse/Spin	Water is not supplied to the drum during the rinse process	- Before rinsing, the appliance spins to drain out any remaining water. Then it fills up with fresh water.
	Rinsing begins before the spin process finishes	- If the appliance detects an unbalanced load, it automatically starts rinsing to correct the imbalance. - If excess foam remains after washing, the water is drained out and refilled to wash the foam away. This is the foam detection function.
	During the spin process, the drum stops and rotates several times	- This is normal. When the appliance detects an unbalanced load, it automatically tries to correct it. - The laundry may be too light. →Try adding one or two bath towels.
	Foam or water remains on the door or door seal	- Some foam or water may remain depending on the state of the laundry or the amount of detergent used. Wipe foam or water away before taking out the laundry.
Time	The displayed remaining time changes	- The display is only a guide and is corrected continually. - The remaining time may increase if the rinse or spin settings are changed or if the appliance detects an unbalanced load and makes an adjustment accordingly.
Detergent and foam	There is not enough/too much foam	- The amount of foam varies depending on the temperature, level and softness of the water. The following can result in less foam - Powdered detergent may have been put directly into the drum. →It should be put into the detergent drawer. (P. 12) - Too little detergent may have been used. - Low foam detergent may be used. - The laundry may be heavily soiled. - The load may be large. The following can result in more foam - Too much detergent may have been used.

Troubleshooting (continued)

	Problem	Cause and Measures
Detergent and foam	Fabric softener overflows	<ul style="list-style-type: none"> - The amount of softener used may have been above the "MAX" line in the detergent drawer. (P. 12) - The detergent drawer may have been closed too strongly and spilt some of the softener.
	There is powdered detergent left on the laundry after washing	<ul style="list-style-type: none"> - Powdered detergent may have been put directly into the drum. →It should be put into the detergent drawer. (P. 12)
Noise	There is an unusual noise or vibration	<ul style="list-style-type: none"> - There may be a metal item in the drum. - The anchor bolts may not have been removed. (P. 36) - The appliance may be installed on a slope or an unstable surface. - Wet clothes may be loaded at the start of washing. →Perform spin process or wring out the laundry beforehand.
	There is noise when water drains out	<ul style="list-style-type: none"> - This is normal. It is the noise of the drain pump working.
	There is a fan rotation sound.	<ul style="list-style-type: none"> - This is normal. The fan cools electric parts.
Others	There is a power cut during operation	<ul style="list-style-type: none"> - Operation will resume from the point it had stopped when the power is recovered. (Auto restart)
	The circuit breaker trips during operation	<ul style="list-style-type: none"> - Figure out the cause and deal with it, then reset the breaker. Operation will resume from the point it had stopped when the power is recovered. (Auto restart)
	The water supply is disrupted	<ul style="list-style-type: none"> - After the water supply is restored, the water may be discoloured for a short while. →Disconnect the water supply hose, run the tap until the water is no longer discoloured, and reconnect the water supply hose. (P. 38)
	The display is unclear	<ul style="list-style-type: none"> - The appliance may be in a brightly lit or sunlit area.

Error Display

 <p>Unable to drain</p>	<p>What to do Check the drain hose for any of following problems:</p> <ul style="list-style-type: none"> - It is blocked with debris. - Hose tip is immersed in water. - It rise higher than 1 m. - Water in the pipe is frozen. <p>Clean the drain filter if blocked. (P. 29) After correcting the problem, open the door then close it, then press "Start/Pause" to restart the machine. (However, the door may not be opened due to water level; in this case, switch off the power, and then re-switch on it and restart the operation.)</p>
 <p>Door is open</p>	<p>What to do Make sure that door is closed properly. Close the door securely and press "Start/Pause".</p>
 <p>Unable to spin-dry</p>	<p>The product has been designed to detect unbalanced loads, particularly small loads, in order to ensure quiet operation and achieve the best results. This is not a malfunction. Perform any of the following solutions.</p> <p>What to do</p> <ul style="list-style-type: none"> - Please try to untangle clumps of clothing. - If you wash large items, e.g. blankets, please reduce the load. - In case of very small load, add one or two bath towels. - Please check that your product is on a stable surface. - Please adjust the feet to ensure the machine is level. <p>After correcting the problem, open the door then close it, then press "Start/Pause" to restart the machine.</p>
 <p>Unable to supply water</p>	<p>What to do Check for any of following problems:</p> <ul style="list-style-type: none"> - Supply tap is closed. - Water pipe or hose is frozen. - Water supply has been disrupted. - Water supply filter is blocked. (P. 27) <p>After correcting the problem, open the door then close it, then press "Start/Pause" to restart the machine.</p>
	<p>An error starting with "H" is displayed.</p> <p>What to do Turn off the tap just to be safe. Check the 2-digit number after "H", unplug the machine and contact a service agent of our company.</p>

Choosing the Right Location

- Make sure to ask a service person for installation. Do not install by yourself.
- If the installation, test run and inspection of the washing machine are not carried out following this installation method, Panasonic will not be liable for any accident or damage caused.

Appliance dimensions

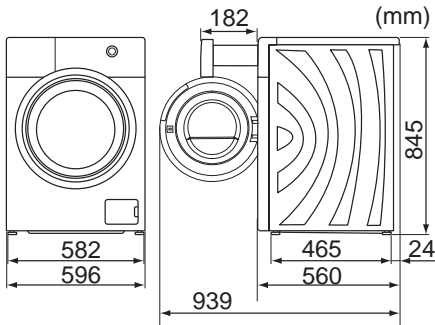

■ Locations the appliance is not to be installed

- In a damp place or where the appliance may be exposed to rain, etc. (As this could cause electric shock or fire)
- Locations that are uneven, or unstable (As this could cause vibration and noise)
- In direct sunlight (As this could cause a malfunction or deformation)

CAUTION

Do not install where temperatures may reach freezing.

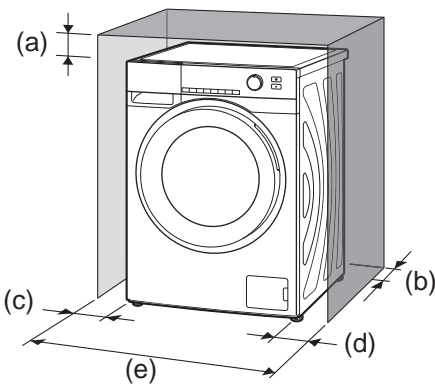

■ Set-in installation

- Install the appliance with easy access to the power plug and socket.
- Install the appliance where there is enough space around it.
 - (a): 3 mm or more above
 - (b): 5 mm or more behind
 - (c): 2 mm or more on the left side
 - (d): 2 mm or more on the right side
 - (e): 64 cm or more

CAUTION

Do NOT let metallic portions of the appliance come into contact with metal sinks or other appliances.

Moving and Installing

Carrying the appliance

Don't do it by yourself alone.



Tilt the appliance backwards, then grip the bottom of the appliance while anyone else holding the rear top.

Installation of bottom plate

Since the accessories for the bottom plate are in the upper foam pad of the package, do not dispose of it.

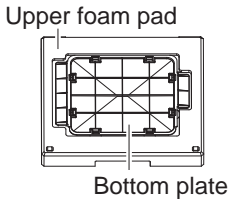

The bottom plate must be installed with the FRONT mark facing frontwards.

- 1 Tilt the body backwards by about 60° and keep it stable, then place the bottom plate beneath the unit.

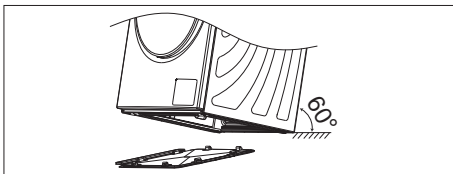

- 2 Hang the rear claws of the bottom plate to the base.

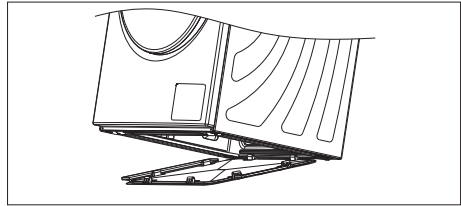

- 3 Snap the front claws into the base until they click.
- 4 Snap the left and right claws into the base securely until they click.

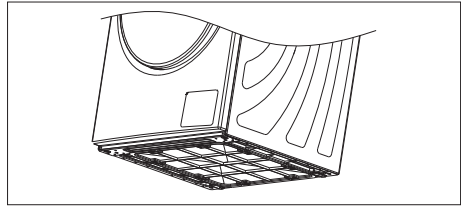

Moving and Installing (continued)

Removing the anchor bolts

The anchor bolts keep the interior of the appliance in place, and protect it from vibration during transportation.

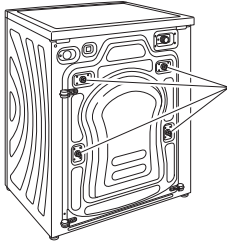

Anchor bolts

- 1 Loosen the 4 anchor bolts (4 pieces) using a spanner.

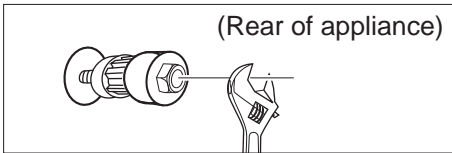

- 2 Turn the rubber part of each bolt counterclockwise and pull it out.

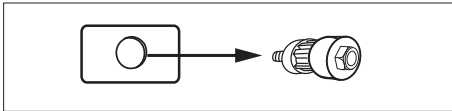

- 3 Attach the cover cap to the hole. If the caps are not attached, foreign objects may enter the appliance and cause a malfunction.

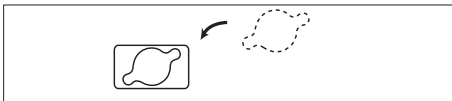

NOTE

- Operating the appliance with anchor bolts still attached will cause excessive vibration. They must be removed before operation.
- Store the anchor bolts. They will be needed when the appliance is moved again in the future.

- When moving the appliance again, the anchor bolts must be attached to the appliance. Attach the anchor bolts in the reverse order they were removed.

Levelling the appliance

Prepare a thin spanner and spirit level. (not supplied)

Use a spirit level to make sure the appliance is level.

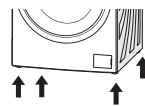
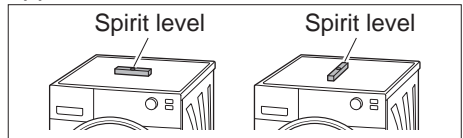

4 adjustable feet

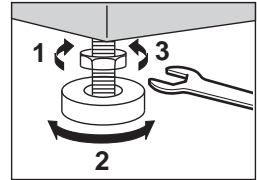

- 1 Loosen the lock nut with the spanner.
- 2 Turn the adjustable foot to adjust the height.
- 3 Tighten the lock nut.

NOTE

- Make sure that all lock nuts are tightened securely and the adjustable feet are still bolted to the appliance. If they are unbolted, the appliance will shake and move around.

Connecting the Hoses

Connect the hoses properly to prevent water leaks.

■ Maximum connection distance of hoses and power cord

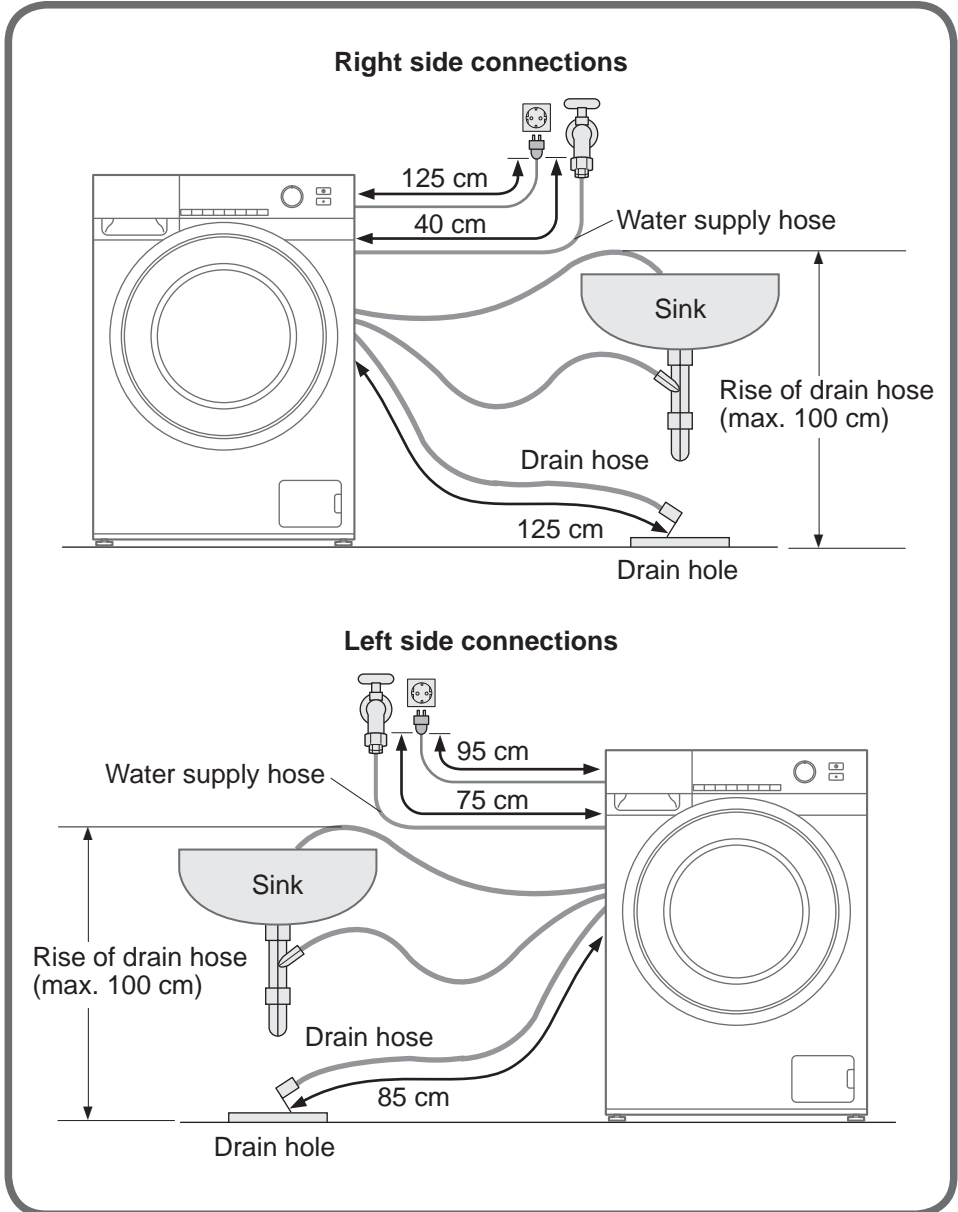

Connecting the Hoses (continued)

Water supply hose

■ Mains water pressure and water flow

- Water pressure: 0.03-1 MPa
If the water pressure exceeds this value, fit a pressure reducing valve.
- Water flow from tap: 5 L/min. or more

■ Connecting the water supply hose

CAUTION

- Do NOT twist, squash, modify or cut the hose.
- Tighten the nut firmly.

- 1 Attach one end of the hose to the water inlet on the appliance and tighten by hand.

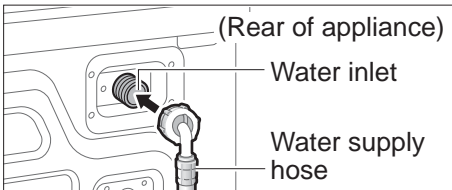

- 2 Attach the other end of the hose to the tap and tighten by hand.

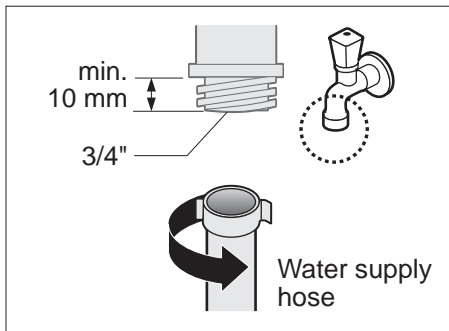

- 3 Turn on the tap slowly and make sure there are no leaks.

Drain hose

■ Draining to a sink or wash basin

CAUTION

Secure the drain hose with an elbow so that it does not come off by water pressure during drainage.

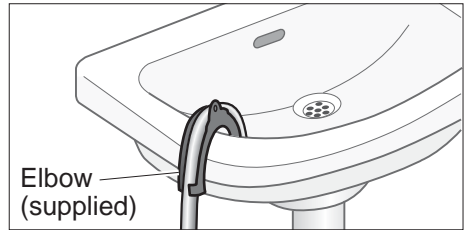

■ Draining to a stand pipe

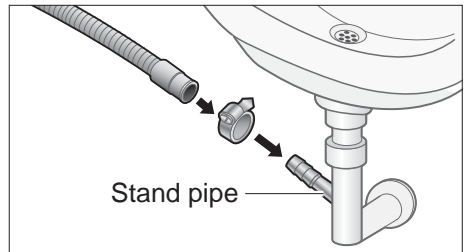

■ Draining to a drain hole

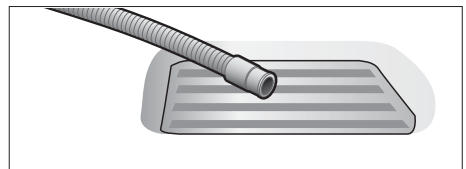

NOTE

- Do not twist, pull out or bend the drain hose.
- Do not put the hose tip under water.

Checking after Installation

Appliance parts checklist

Anchor bolts

- Have you removed all 4 anchor bolts and fitted cover caps? (P. 36)

Power plug

- Is the appliance plugged into an AC 220-240 V household socket?

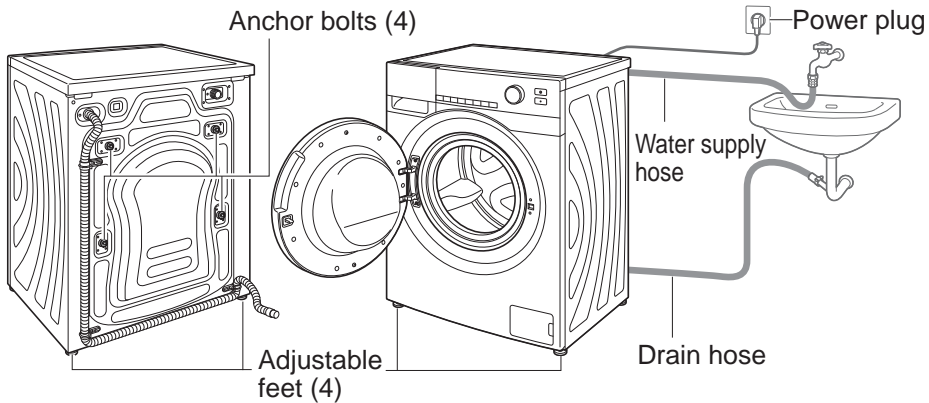

Adjustable feet

- Are they stable and securely tightened? (P. 36)
- Is the appliance level? (P. 36)

Water supply hose

- Is the water supply hose properly connected? Is it free from leaks? (P. 38)

Installation place

- Is the appliance on a flat, stable surface?
- Does it run without vibrating? (P. 36)



Drain hose

- Is the drain hose properly connected? Does it drain normally? (P. 38)

Checking after Installation (continued)

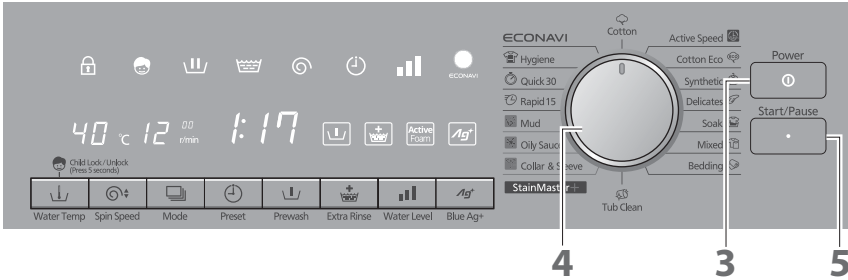
Test run



- 1 Turn on the tap.
- 2 Close the door without any laundry in the drum.
- 3  Switch on the appliance.
- 4  Select the “Rapid 15” programme.
- 5  Start operation.

Water leaks

- Check the appliance and hose joints for leaks. (P. 37)

Abnormal noise

- Make sure the appliance is level. (P. 36)



Error display

U11 Unable to drain (P. 33)

U14 Unable to supply water (P. 33)

- After resolving an error, open and close the door and press “Start/Pause” to resume the test.

Power and Water Consumption

Programme	Temperature	Water level	Load	Power consumption*1	Water consumption*1	Time*1
 Cotton	Cold	High	10 kg	0.15 kWh	95 L	1:02
	40 °C	High	10 kg	1.0 kWh	95 L	1:17
	60 °C	High	10 kg	1.5 kWh	95 L	1:32
 Cotton Eco	60 °C*2	High	10 kg	1.05 kWh	81 L	1:35
ECONAVI	Cold	High	10 kg	0.4 kWh	94 L	2:23
	40 °C	High	10 kg	1.1 kWh	94 L	2:38

*1 The power, water consumption and time indicated in the table may vary depending on variations in pressures, water hardness and temperatures, room temperatures, types and amounts of laundry, voltage fluctuations and functions to be used.

*2 For normally soiled laundry with the rated capacity, “Cotton Eco” programme with 60 °C water and high water level is recommended.

Specifications

Model No.	NA-120VX7
Rated voltage	220 - 240 V
Rated frequency	50 Hz
Maximum energy rated power input	1670 - 1990 W
Heating energy rated power input	1610 W (230 V)
Maximum spin speed	1200 r/min
Product dimensions	596 mm (W) × 560 mm (D) × 845 mm (H)
Product weight	66 kg
Maximum mass of dry cloth	10 kg
Water consumption	Refer to "Power and Water Consumption". (P. 41)
Pressure of tap water	0.03 - 1 MPa

■ Check the power supply

The rated power of the appliance is shown on the name plate. Make sure it matches the specifications of your residence.

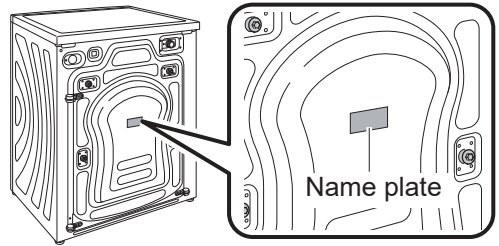

Panasonic®

使用與安裝 說明書

洗衣機
(家用)

型號

NA-120VX7



目錄

安全注意事項	4
使用須知	8
洗衣	14
自選功能	22
保養	27
疑難排解	30
安裝／其他	34

感謝您購買本產品。

- 為達到最佳的效能和安全性，使用前請詳細閱讀相關指示。
- 請妥善保存本手冊，以供日後參考之用。



AWW9901A5MA0-0B0

目錄

安全注意事項	■ 安全注意事項	4
--------	--------------------	---

使用須知	■ 了解您的洗衣機	8
	■ 洗衣前	9
	■ 控制面板	10
	■ 洗衣劑	12

洗衣	■ 洗衣 (基本方法)	14
	■ 程序列表	16
	■ 程序詳情	18
	■ 清洗建議	20

自選功能	■ 更改程序設定	22
	• 調整水溫	
	[ Water Temp (水溫)]	22
	• 調整水位	
	[ Water Level (水位)]	22
	• 調整脫水轉速	
	[ Spin Speed (脫水轉速)]	23
	• 設定程序完結時間	
	[ Preset (預設)]	23
	■ 使用自選功能清洗	24
	• 選擇並運行過程	
[ Mode (模式)]	24	
• 預洗		
[ Prewash (預洗)]	24	
• 徹底過水		
[ Extra Rinse (額外過水)]	25	
• 衣物除菌		
[ Blue Ag+ (光動銀離子) (最多3 kg)]	25	

■更改洗衣機設定	26
•關閉鳴響.....	26
•設定兒童安全鎖 [Child Lock (兒童安全鎖)] ..	26
•關閉「Active Foam (泡沫淨)」功能	26

保養

■保養.....	27
•供水過濾器.....	27
•如果供水管結冰.....	27
•洗衣機.....	28
•洗衣桶.....	28
•洗衣劑格.....	28
•排水過濾器.....	29

疑難排解

■疑難排解.....	30
■錯誤顯示.....	33

安裝／其他

(安裝事項請向服務人員查詢)

■選擇正確的位置	34
■搬運及安裝	35
■連接水管	37
■安裝後的檢查	39
■用電量與用水量	41
■規格.....	42

安全注意事項

請詳閱並遵循以下安全注意事項。



可能導致嚴重受傷或死亡。

為保障閣下及家人的安全

- 肢體、感覺或精神殘障的人士，以及缺乏經驗與相關知識的人士（包括小孩），必須在負責其安全的人士監管指導下，方可使用本洗衣機。
- 請善盡監管之責，避免兒童將洗衣機作嬉戲之用。
- 請確保洗衣機遠離火焰。請勿將易燃物料或附有易燃物料的衣物放入洗衣桶內。請確保洗衣機遠離易燃物品。（以免發生爆炸或起火）
例如：煤油、汽油、苯／稀釋劑、酒精等。
- 洗衣桶完全停止之前，請勿觸碰，否則可能導致受傷。

洗衣機接地

- 請確保經銷商已為洗衣機接地。
如果未接地，一旦漏電可能導致觸電。

警告

避免發生觸電、過熱、燃燒或起火

- 請使用符合額定要求的獨立電源插座。請勿使用插頭轉接器或延長線。
- 請勿使用受損的電線或插頭。如果電線損壞，必須由製造商或其服務代理商，或其他合資格人士更換，以免發生危險。
- 手濕時請勿觸摸電線與插頭。
- 務必將插頭完全牢固插入電源插座。
- 從電源插座拔出插頭時請勿抓住或拉扯電線。
- 清潔洗衣機前請先拔掉電線。

維修

- 請勿自行拆卸、維修或改裝洗衣機。
如果洗衣機故障或失靈，請立即停止使用，並拔掉電線，然後聯絡附近的維修中心進行維修。

安全注意事項 (續)

⚠ 注意

可能導致受傷或財物損失。

正確使用

- 本洗衣機只適合清洗標籤為可機洗的衣物。
- 請勿將洗衣機連接到熱水管。
- 請勿在底座開口下放置地氈等遮擋物。

避免發生漏水

- 請使用隨附的新水管，不應使用舊水管。
- 如果一段時間內不會使用洗衣機（例如假期），請關掉水龍頭。漏水可能在無人在家時發生，亦會導致財物損失。

避免受傷及燙傷

- 關閉機門時，請勿將手指置於門鉸附近。
- 請勿攀爬洗衣機。

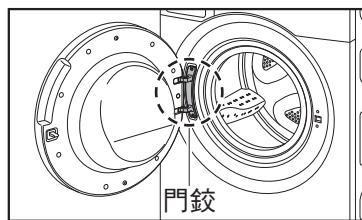

⚠ 注意

- 高溫洗衣時，請小心燙傷。排水管、洗衣桶、機門玻璃及衣物溫度都會較高。

避免洗衣機及衣物損壞

- 啟動洗衣機前請確保已移除螺栓。否則可能導致脫水期間機身劇烈晃動。
- 請勿清洗附有大量蔬菜油、潤膚油等污漬的衣物。因為油份可能會變熱，使機門膠圈變型導致漏水。
- 請勿清洗防水床單或衣物，或進行過水或脫水。否則在脫水過程中，洗衣機可能會劇烈晃動或發生故障，導致受傷、洗衣機損壞或漏水。
例如：雨衣、潛水衣等。

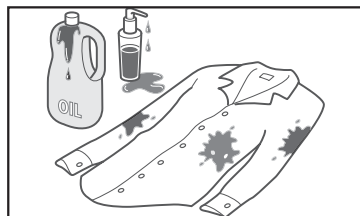

了解您的洗衣機

洗衣劑格 (第 12 頁)

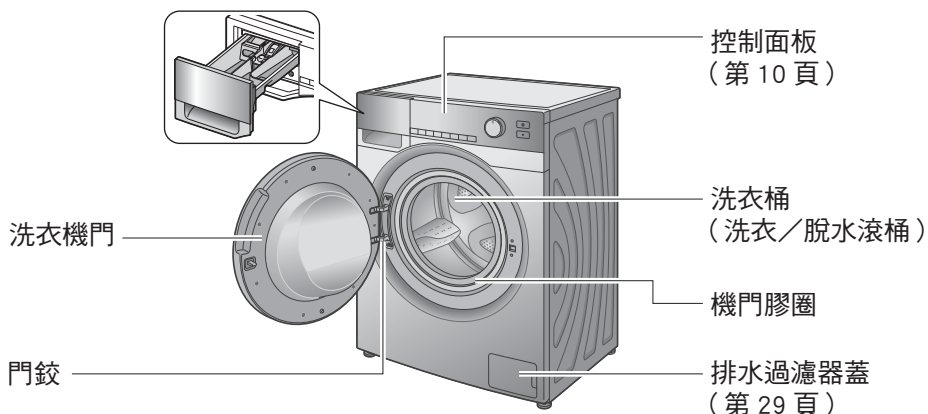

(洗衣機背面)

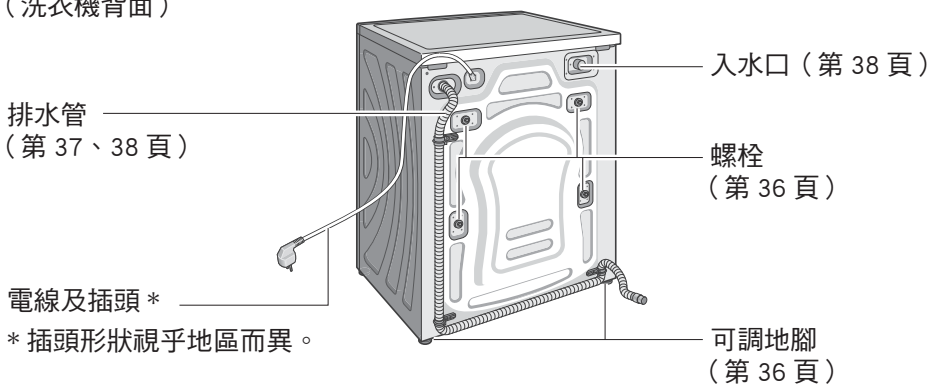

配件

水管彎頭 (第 38 頁)



供水管 (第 37、38 頁)



罩蓋 (4) (第 36 頁)



底板 (第 35 頁)

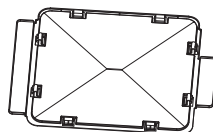

洗衣前

使用前的檢查事項

如果是首次使用或長時間未使用，請檢查以下事項。

- 確認供水管及排水管已妥善連接。（第37、38頁）
- 開啟水龍頭時，供水管連接處正常。
- 已插上電源插頭。

首次使用前

洗衣機出廠前會注水進行檢查，因此機內可能有水滴或水珠凝結的情況。要沖洗掉任何殘餘物等，請遵循以下操作：

- 「Cotton（棉質）」程序
- 預設40 °C
- 無洗衣劑及衣物

準備洗衣

請參閱衣物清洗標籤，並根據顏色、布料及骯髒程度將衣物分類。這有助您選擇合適的洗衣程序及水溫。

■ 帶有污漬的物件

- 在污漬上使用去污劑。
- 建議選擇「StainMaster+（去污大師+）」（第17頁）程序來去除污漬。

■ 分類

- 請分開清洗會脫色的衣物。（牛仔布、深色物料等）。

■ 將衣物放入洗衣桶前

為免損壞衣物或導致洗衣機故障，請遵循以下步驟。

- 請移除衣物中的異物（硬幣、扣針、萬字夾、釘）。

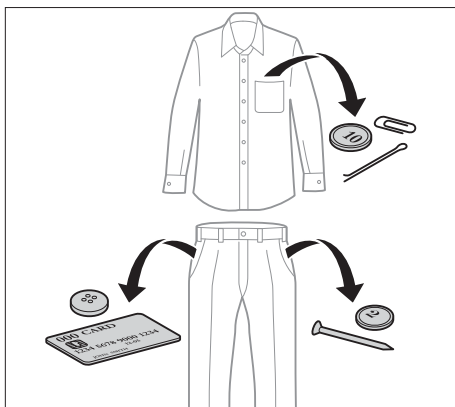

- 請繫緊圍裙等衣物上的繩索。
- 絨質衣物：請內外反轉。
- 帶有拉鍊的衣物：請拉起拉鍊並內外反轉。
- 細件物品、鋼線胸圍、蕾絲物品：請放入洗衣袋內。

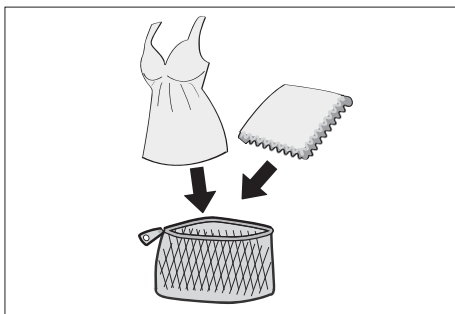

- 洗衣前，請刷除任何毛髮、動物毛屑、砂礫等異物
- 泥漬或頑固污漬：請先輕輕地手洗。

控制面板

控制

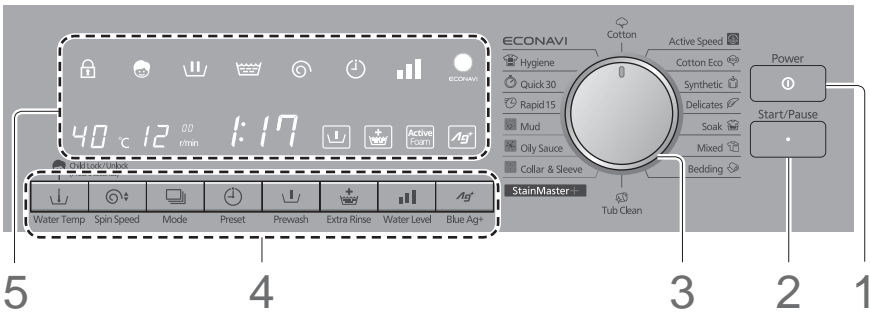

1. 電源按鈕 [Power ①]

2. 開始／暫停按鈕 [Start/Pause]

按此按鈕以開始或暫停操作。

3. 程序選擇旋鈕

用以選擇適合衣物的洗衣程序。
(第16頁)

4. 控制按鈕

用以更改洗衣設定，或選擇自選功能。

	Water temperature (水溫) (第 22 頁)
	Child Lock (兒童安全鎖) *1 (第 26 頁)
	Spin speed (脫水轉速) (第 23 頁)
	Mode (模式) (第 24 頁)
	Preset (預設) (第 23 頁)
	Prewash (預洗) (第 24 頁)
	Extra Rinse (額外過水) (第 25 頁)
	Water Level (水位) (第 22 頁)
	Blue Ag+ (光動銀離子) (第 25 頁)

5. 顯示螢幕 (第 11 頁)

*1 兒童安全鎖：按住此按鈕至少5秒鐘，以鎖定洗衣機門和其他按鈕。

註

- 要關閉電源並重開，請按「Power (電源)」按鈕先關閉電源，並在顯示螢幕關閉後方再重開。



按住至少3秒鐘。

關閉

- 如果開機後10分鐘內並未按下「Start/Pause (開始／暫停)」按鈕，洗衣機會自動關閉。

顯示屏幕

以下同時展示所有標示以便說明。

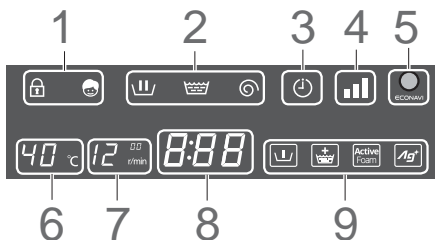

1. 上鎖

：機門鎖上

：機門及按鈕全部鎖上（兒童安全鎖）

2. 過程

各個標示會閃爍以顯示目前洗衣程序，並在程序結束後熄滅。

	洗衣
	過水
	脫水

3. 預設

（第23頁）

4. 水位

5. ECONAVI（智慧節能）指示燈

選擇「ECONAVI（智慧節能）」程序時會亮起。

ECONAVI（智慧節能）偵測時會閃爍。

（第21頁）

6. 水溫

7. 脫水轉速

8. 剩餘時間

此標示會顯示距離程序結束的大約時間。

錯誤顯示

洗衣機故障時會顯示錯誤代號。

（第33頁）

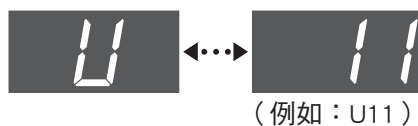

9. 自選功能

顯示已選的自選功能。（第24、25頁）

註

- 如果運作期間停電，洗衣機會在電源恢復後從中斷階段恢復運作。（自動重啟）

洗衣劑

- 按下「Start/Pause（開始／暫停）」按鈕前，應先倒入洗衣劑等產品。
- 閱讀洗衣劑或其他產品包裝上的指引，並根據洗衣量、骯髒程度和水硬度適量使用。

洗衣劑、軟水劑、漂白水、去污劑

- 使用洗衣桶清潔劑時，同樣倒在此格內。（第28頁）

柔順劑

柔順劑將於最後的過水程序中自動加入。

- 請勿超過「MAX」（130 ml）線。

泡沫產生器

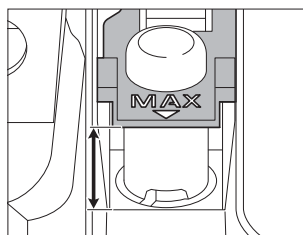

預洗用洗衣劑

使用「Prewash（預洗）」功能時（第24頁）

洗衣劑格

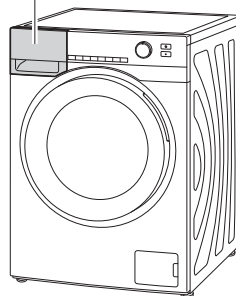
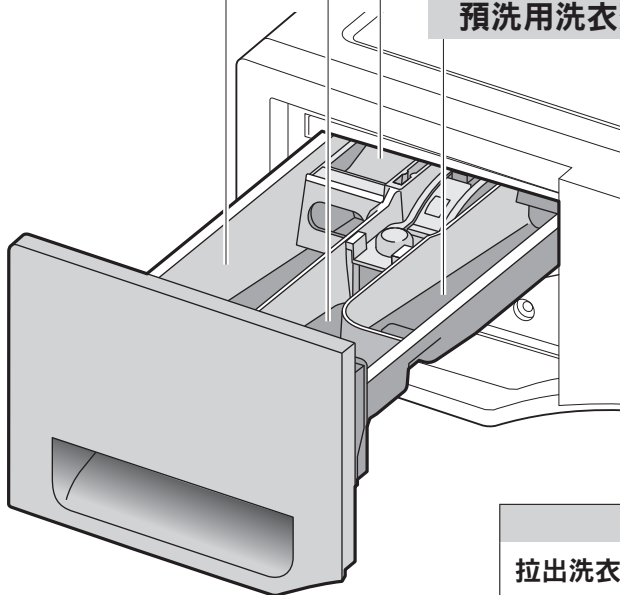

注意

拉出洗衣劑格時，請勿使用洗衣機。
否則可能導致漏水。

洗衣劑

使用低泡沫量的洗衣劑。

- 為免洗衣粉積聚於洗衣劑格內：
 - 請用布抹乾洗衣劑格內部。
 - 壓碎結塊的洗衣粉。

如果格內留有洗衣粉，請將殘餘洗衣粉直接倒入洗衣桶內。

- 如果洗衣前忘記加入洗衣劑，請排清洗衣桶內的水，然後重新開始程序。

（註）

- 如果包裝上的指示說明應將洗衣劑加入洗衣桶，請勿將其加入洗衣劑格。洗衣劑可能無法順暢流出，部分可能殘留在洗衣劑格中，導致水從洗衣格中溢出。

- 請勿於泡沫產生器內加入洗衣劑

■ 預洗

- 預洗及正式洗衣需要不同的洗衣劑。
- 正式洗衣時請使用洗衣粉。洗衣液會在預洗程序中排走。

軟水劑

如果您居住區域的水質較硬（總硬度 1.3 mmol/L 或以上），我們建議使用軟水劑。軟水劑有助減少洗衣劑用量，並避免形成損壞洗衣機的水垢。

（註）

- 有關水硬度的詳細說明，請連絡您附近的專家。

柔順劑

避免衣物產生靜電。

- 如果洗衣後洗衣劑格內留有任何柔順劑，請將水倒入格內以稀釋柔順劑。（請



勿超過最高位）格內殘餘柔順劑：您可以用濕布抹走。

洗衣 基本方法

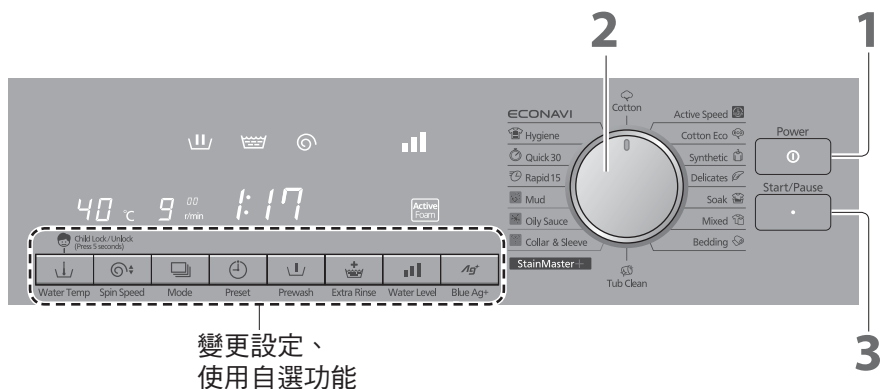

註

- 請勿讓衣物夾在機門內。
這會導致機門膠圈損壞。

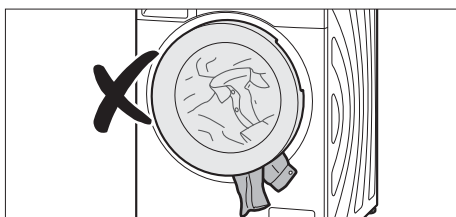

- 請勿將過量衣物放入洗衣桶中。
這可能會造成劇烈晃動或洗衣機損壞。

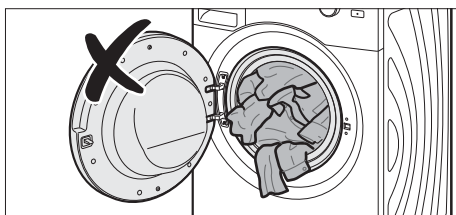

■ 要在運作期間打開機門

(運作期間機門會鎖上)

Start/Pause 按「Pause (暫停)」。

 (機門在「嗒」一聲後解鎖)

- 脫水期間，洗衣桶停止轉動前可能需時約1分鐘。

■準備

- 將衣物分類，並放入洗衣桶內。
(第9頁)
- 倒入洗衣劑。(第12頁)

1  **Power 開啟電源。**

2  **選擇程序。**
(第16、17頁)

屏幕會顯示所需時間。

■變更設定

■使用自選功能

3  **Start/Pause 開始運作。**

- 磅重(約30秒鐘)

 (磅重結果顯示)
部分程序不會為衣物磅重。
(第16、17頁)

- 所需時間顯示(經重新計算) (例子)

 (例子)

程序結束。

(洗衣機會鳴響，機門會解鎖。)

註

- 衣物會互相染色，因此請在程序結束後立即取走彩色衣物。

變更設定

選擇程序後，您可以更改以下設定。

 水溫(第22頁)
Water Temp

 脫水轉速(第23頁)
Spin Speed

 預設計時器(第23頁)
Preset

 水位(第22頁)
Water Level

使用自選功能

選擇程序後，您可以加入以下自選功能。

 模式(第24頁)
(選擇運行洗衣、過水或脫水程序)
Mode

 預洗(第24頁)
Prewash

 額外過水(第25頁)
Extra Rinse

 光動銀離子(第21、25頁)
Blue Ag⁺

註

- 您可以更改的設定及可以加入的自選功能，視乎您選擇的程序而異。(第18頁)

程序列表

程序	說明	洗衣量上限 (kg)	時間*1
 Cotton (棉質)	棉質、麻質和棉質混紡衣物的日常洗衣程序 (例如T恤、內衣褲、毛巾及桌布)	10.0	0:57 - 1:17
 Cotton Eco (棉質 (環保))	洗衣時間較長，但能源及水量消耗較Cotton (棉質) 程序為少。	10.0	1:00 - 1:20
 Synthetic (合成纖維)*2	輕柔清洗化學纖維。	5.0	0:53
 Delicates (纖細衣物)*2	適用於內衣褲及可機洗的絲質衣物。	2.0	0:41
 Soak (高濃度浸洗)	適用於非常骯髒的衣物。	5.0	1:47
 Mixed (混合衣物)	適用於混合衣物，例如棉質、麻質和合成纖維衣物。	10.0	1:12 - 1:47
 Bedding (寢具)*2	適用於大幅布匹，例如毛氈、窗簾和床罩。	3.0	1:21

註

- 程序所需時間視乎水溫、水壓、排水情況及衣物數量而異。

程序	說明	洗衣量上限 (kg)	時間*1	
ECONAVI (智慧節能)	適用於混合材質，例如棉質、麻質和合成纖維。(詳情請參閱第21頁)	10.0	1:18 - 2:23	
 Active Speed (快捷洗衣)	以較Cotton(棉質)程序快的速度清洗少量衣物。	5.0	0:49	
 Quick 30 (快洗 30)*2	30分鐘快洗不太骯髒的棉麻混紡衣物。	5.0	0:30	
 Rapid 15 (速洗 15)*2	15分鐘速洗少量不太骯髒的衣物。	2.0	0:15	
 Hygiene (潔淨清洗)	清洗嬰兒衣物、桌布及床單。	10.0	1:43 - 1:58	
 Tub Clean (除菌淨桶)	清洗洗衣桶。	無衣物	3:36	
StainMaster+ (去污大師+) 適用於去除污漬。	 Mud (泥漬)	適用於泥漬。	10.0	2:27 - 3:12
	 Oily Sauce (油性醬汁)	適用於油性醬汁的污漬。	10.0	2:07 - 2:47
	 Collar & Sleeve (衣領袖口)	適用於衣領袖口的污漬。	10.0	2:17 - 3:02

*1 使用程序預設水溫。

*2 按「Start/Pause(開始/暫停)」按鈕後，不會為衣物磅重。程序會直接開始。

程序詳情

程序	設定	自動設定			
		水溫 (°C)*1	水位*2	脫水轉速 (r/min)	水溫 (°C)*1
 Cotton (棉質)		40	■ ■ ■	900	冷水、30、40、50、60
 Cotton Eco (棉質(環保))		40	■ ■ ■	1200	冷水、30、40、50、60
 Synthetic (合成纖維)		30	■ ■ ■	700	冷水、30、40
 Delicates (纖細衣物)		30	■ ■ ■	500	冷水、30、40
 Soak (高濃度浸洗)		40	■ ■ ■	900	冷水、30、40
 Mixed (混合衣物)		40	■ ■ ■	1000	冷水、30、40
 Bedding (寢具)		冷水	■ ■ ■	700	冷水、30
ECONAVI (智慧節能)		冷水	■ ■ ■	1000	冷水、30、40、50、60
 Active Speed (快捷洗衣)		40	■ ■ ■	900	冷水、30、40
 Quick 30 (快洗 30)		冷水	■ ■ ■	900	無法更改
 Rapid 15 (速洗 15)		冷水	■ ■ ■	900	無法更改
 Hygiene (潔淨清洗)		90	■ ■ ■	900	60、90
 Tub Clean (除菌淨桶)		40	■ ■ ■	900	無法更改
 Mud (泥漬)		40	■ ■ ■	900	無法更改
 Oily Sauce (油性醬汁)		40	■ ■ ■	900	無法更改
 Collar & Sleeve (衣領袖口)		40	■ ■ ■	900	無法更改

*1 選擇「冷水」後，不會顯示任何溫度標示。

*2 H：■ ■ ■ 高；M：■ ■ ■ 中；L：■ ■ ■ 低

*3 特定程序會自動運行「Active Foam (泡沫淨)」。

設定範疇		自選功能				
水位*2	脫水轉速 (r/min)	Mode (模式)	Prewash (預洗)	Extra Rinse (額外過水)	Blue Ag+ (光動銀離子) (最多3 kg)	Active Foam (泡沫淨)*3
H、M、L	500、700、900、 1000、1200	✓	✓	✓	✓	✓
H、M、L	500、700、900、 1000、1200	✓	✓	✓	✓	✓
H、M、L	500、700、900	✓	✓	✓	✓	✓
無法更改	無法更改	✓	—	✓	✓	—
H、M	500、700、900、 1000、1200	✓	—	✓	✓	✓
H、M、L	500、700、900、 1000、1200	✓	✓	✓	✓	✓
H、M	500、700	✓	—	✓	✓	✓
無法更改	900、1000、1200	—	—	—	✓	✓
M、L	500、700、900、 1000、1200	✓	—	—	✓	✓
H、M、L	500、700、900	✓	—	—	—	✓
H、M、L	500、700、900	—	—	—	—	✓
H、M、L	500、700、900	—	—	✓	✓	—
無法更改	無法更改	—	—	—	—	—
無法更改	500、700、900、 1000、1200	✓	✓	✓	✓	✓
無法更改	500、700、900、 1000、1200	✓	✓	✓	✓	✓
無法更改	500、700、900、 1000、1200	✓	✓	✓	✓	✓

清洗建議

「Delicates (纖細衣物) 」程序

■ 洗衣時

- 將衣物逐一疊放在洗衣桶內。
- 要完全過水，請使用「Extra Rinse (額外過水)」功能 (第25頁)

■ 晾曬時

- 將羊毛及尼龍衣物攤平。
- 將白色或淺色尼龍衣物晾曬於陰涼處。(遠離陽光直射)
- 使用衣架晾曬襯衫、上衣及長褲。

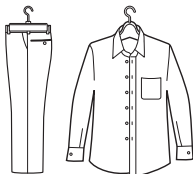

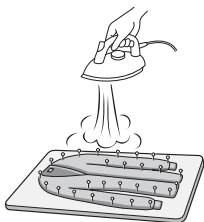

■ 如果衣物在清洗後縮水

- 1 在熨衫板上將衣物攤開至原來大小。
- 2 用襟針固定其大小形狀。
- 3 用蒸汽熨平後再晾乾。



「Bedding (寢具) 」程序

■ 可清洗的物件

- 帶有  (水洗) 或  (手洗) 標誌的物件。
- 100 % 合成纖維及100 % 棉質的毛氈
- 床單 ● 床罩
- 100 % 合成纖維底墊

註

- 每次只能清洗一件物件。
- 請勿清洗羊毛、絲質或長毛假皮革製品。
- 請勿清洗電熱氈。
- 請勿使用洗衣袋。(洗衣袋會阻礙洗衣桶轉動。)

■ 將毛氈入洗衣桶內

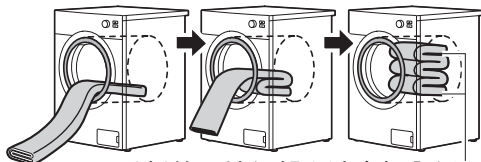
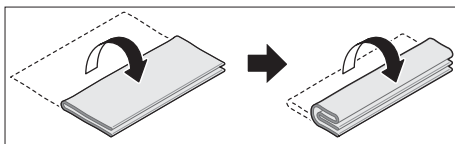

毛氈的兩端須朝向洗衣桶內側。

註

- 請勿將毛氈或床罩捲成球狀或隨意摺疊。否則可能導致劇烈晃動，並損壞衣物或洗衣機。

「ECONAVI (智慧節能)」 程序

本程序可偵測水溫、洗衣量及衣物材質（棉質、合成纖維等），以判斷出最適合的洗衣時間及水量，從而節省能源及用水。

節省時間及能源的做法包括少量洗衣、一次過清洗大量易乾的衣物（例如合成纖維），以及使用較高水溫。

註

- 建議洗衣桶內只放置乾身衣物。如果放入大量濕透衣物，ECONAVI（智慧節能）偵測可能無法正常運作。

「Blue Ag+ (光動銀離子)」 (最多3 kg)

本功能會在過水期間，使用溶解在水中的銀離子及紫外線（UV）為衣物除菌。

註

- 「Blue Ag+ (光動銀離子)」程序專為洗衣而設，因此請勿將程序處理的水用作其他用途，例如飲用或煮食。
- 衣物、洗衣劑、柔順劑及軟水劑種類可能影響結果。
- 如果衣物經「Blue Ag+ (光動銀離子)」後，穿著時感到痕癢或異常，請勿再穿著該衣物。

- 使用「Blue Ag+ (光動銀離子)」程序時，同時加入柔順劑或洗衣液，可能導致衣物變黃。如果發生此情況，請用洗衣粉清洗變黃衣物，切勿使用「Blue Ag+ (光動銀離子)」程序。這會讓變黃衣物重現潔白。（60 °C 水溫更有效）

■更換銀離子零件

洗衣機開啟後，如果Blue Ag+ (光動銀離子) 指示燈閃爍，請更換內部銀離子零件以保持除菌效果。

「Blue Ag+ (光動銀離子)」指示燈在過水期間閃爍，則代表正在除菌。

註

- 按每星期使用兩次、每次用水正常（水硬度、水量及水溫）情況計算，「Blue Ag+ (光動銀離子)」能有效運作約三年。
- 銀離子零件使用壽命過後，仍可使用本洗衣機，惟再無除菌效果。
- 如須更換，請向服務人員查詢。

「Active Foam (泡沫淨)」

「Active Foam (泡沫淨)」會隨第19頁標示的程序啟動。

 標示會於設定好後亮起，並於運作期間閃爍。

更改程序設定

■準備

- 將衣物分類，並放入洗衣桶內。
(第9頁)
- 倒入洗衣劑。(第12頁)

1  開啟電源。

2  選擇程序。
(第16、17頁)

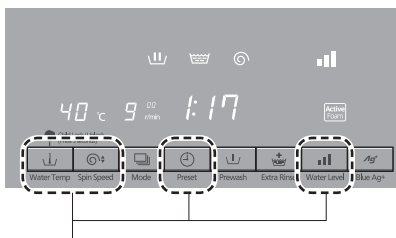

3 更改程序設定。
●設定範疇視乎程序而異。
(第18頁)

4  開始運作。

調整水溫

Water Temp (水溫)

您可根據衣物類型及骯髒程度調整水溫。

3  按下按鈕。
Water Temp

每次按下按鈕，水溫標示即會轉變。

■設定指引

- 高溫：
白色、棉質、非常骯髒的衣物
- 低溫：
彩色、易縮水及不太骯髒的衣物

調整水位

Water Level (水位)

您可以調整洗衣水量。

3  按下按鈕。
Water Level

每次按下按鈕，水位標示即會轉變。

- ：高 (H)
- ：中 (M)
- ：低 (L)

調整脫水轉速

Spin Speed (脫水轉速)

調整脫水轉速以更徹底乾衣或減少衣物皺摺。

3



按下按鈕。

每次按下按鈕，脫水轉速標示即會轉變。

■ 設定指引

- 高速：
更徹底乾衣
- 低速：
減少衣物皺摺

註

- 程序開始後直至洗衣過程完結前，您都可以調整脫水轉速。暫停程序並執行步驟3及步驟4。

設定程序完結時間

Preset (預設)

您可以設定在多少小時後完成清洗。

3



按下按鈕。

每次按下按鈕，預設標示即會轉變。

長按「 Preset (預設)」以調整時間。

■ 設定範疇

最多24小時(以小時為單位)

■ 查看預設時間



按下按鈕。

■ 取消設定



關閉電源。

(取消所有設定)

註

- 確保在關上機門後，方按下「Start/Pause (開始/暫停)」按鈕啟動「Preset (預設)」。
- 請勿使用難以溶解的洗衣劑，因為這可能會在清洗前結塊，導致無法流入洗衣桶內。
- 「Delicates (纖細衣物)」或「Tub Clean (除菌淨桶)」程序均無法設定完結時間。

使用自選功能清洗

您可以結合使用各項自選功能及程序。

■準備

- 將衣物分類，並放入洗衣桶內。
(第9頁)
- 倒入洗衣劑。(第12頁)

1  開啟電源。

2  選擇程序。
(第16、17頁)

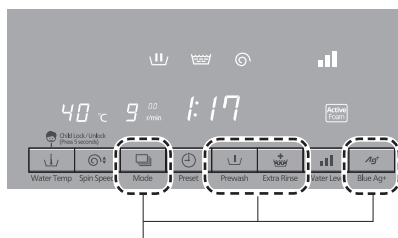

3 加入自選功能。

- 選項適用與否視乎程序而定。
(第18頁)
- 選擇不適用的功能時，洗衣機會發出鳴響。

4  開始運作。

選擇並運行過程

 Mode (模式)

您可以選擇並運行結合洗衣、過水及脫水的過程。

3  按下按鈕。
Mode

每次按下按鈕，標示即會轉變。

 *2	洗衣
 *1	過水
 *1	脫水
	洗衣及過水
 *1	過水及脫水
	洗衣及脫水

*1 如果洗衣桶內有水，則先排水。

*2 不會排水。

預洗

 Prewash (預洗)

您可以添加預洗選項，合共清洗衣物兩次。這對非常骯髒的衣物相當有用。

3  按下按鈕。
Prewash

 標示會隨按下按鈕亮起（已啟動）或消失。

徹底過水

 Extra Rinse (額外過水)

如果擔心有洗衣劑殘留於衣物上，可以添加額外過水過程。

3



按下按鈕。

標示會隨按下按鈕亮起（已啟動）或消失。

註

- 程序開始後直至洗衣過程完結前，您都可以調整「Extra Rinse（額外過水）」設定。暫停程序並執行步驟3及步驟4。

衣物除菌

 Blue Ag+ (光動銀離子)
(最多3 kg)

使用銀離子及紫外線（UV）為衣物除菌。（第21頁）

3



按下按鈕。

標示會隨按下按鈕亮起（已啟動）或消失。



註

- 如果設定了「Blue Ag+（光動銀離子）」，將會同時使用「Extra Rinse（額外過水）」功能。

更改洗衣機設定

關閉鳴響

您可以關閉程序結束時發出的鳴響

- 1  開啟電源。
- 2  按住至少5秒鐘。
鳴響設定會在「嗶」一聲之後關閉。





■開啟

執行與關閉相同的操作。鳴響設定會在「嗶嗶」兩聲之後啟動。



設定兒童安全鎖

Child Lock (兒童安全鎖)

您可以鎖上機門，防止兒童自行打開。控制按鈕亦會同時鎖上。

- 1  開啟電源。
- 2  按住至少5秒鐘。
(  標示亮起。)

■解鎖

- 1  按住至少5秒鐘。
(  標示消失。)

- 無須理會嗶聲，長按直至打開兒童安全鎖。

關閉「Active Foam (泡沫淨)」功能

您可以關閉「Active Foam (泡沫淨)」功能。

- 1  開啟電源。
- 2  選擇「Tub Clean (滾桶清洗)」。
- 3  按住至少3秒鐘。
Water Level (顯示「002」， 標示亮起。)
- 4  按下按鈕。
Water Level (顯示「002」， 標示消失。)
- 5  按下按鈕。
(設定完成，電源關閉)

■開啟

執行與關閉相同的操作。 標示會在步驟4亮起。

保養

供水過濾器

如果出現供水異常，請清潔過濾器。



供水過濾器

- 1 關上水龍頭。
- 2 開啟電源，洗衣桶內不要放入任何衣物或洗衣劑，然後啟動「Cotton（棉質）」程序。
- 3 1分鐘後關閉電源。此時供水管內的水已排出。
- 4 移除供水管，然後清潔供水過濾器。

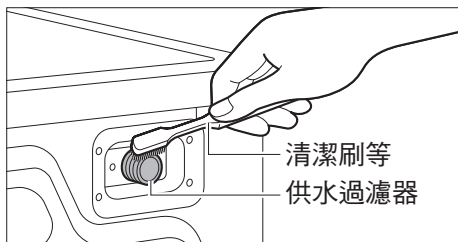

清潔刷等
供水過濾器

如果供水管結冰

- 1 用熱毛巾包住供水管接口。

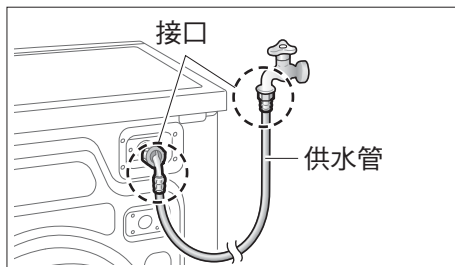

- 2 往洗衣桶內倒入2至3公升熱水（約50℃）。

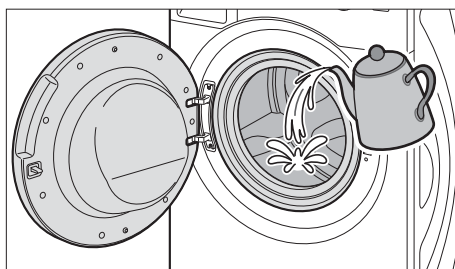

- 3 等候10分鐘，選擇並執行「Mode（模式）」功能中的脫水過程（第24頁）。

自選功能

保養

保養 (續)

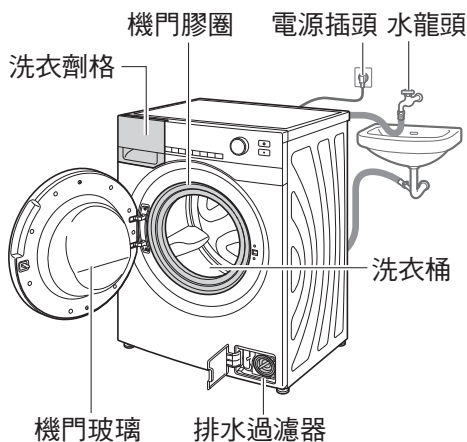

洗衣機

用軟布抹走水分或污漬。

註

- 請勿用水潑濕洗衣機。
- 請勿使用去油劑、天拿水或含有酒精或石蠟油的产品。

■ 機門膠圈及玻璃

移除線頭或異物。

■ 洗衣機

用布及溫和的廚房清潔劑拭擦清潔。

洗衣桶

每月運行「Tub Clean (除菌淨桶)」程式，同時加入市面有售的洗衣桶清潔劑。遵循洗衣桶清潔劑說明指引。

註

- 如果您使用水垢清潔劑，請遵循說明指示。

洗衣劑格

用水清洗洗衣劑格。
積存的洗衣劑可能會滋生霉菌。

- 1 拉出洗衣劑格。

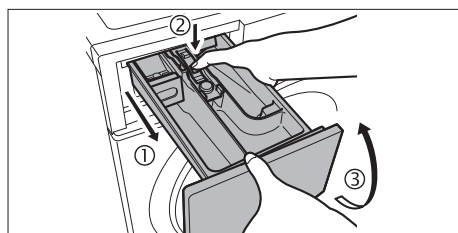

- 2 雙手拇指放在圖中所示位置，用力朝箭咀方向往兩邊拉，然後推高柔軟劑蓋，以從洗衣劑格中將其移除。

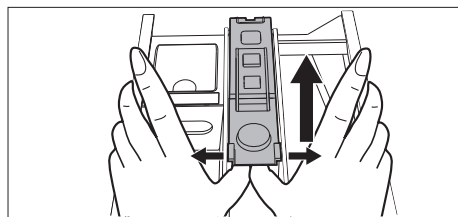

- 3 用水清洗洗衣劑格。
- 4 裝回柔軟劑蓋及洗衣劑格。

排水過濾器

每月移除排水過濾器上的線頭。積存的線頭會阻礙排水。

- 1 關閉洗衣機電源並拔掉插頭。
- 2 打開前面的排水過濾器蓋，放置容器以盛載排出的水。

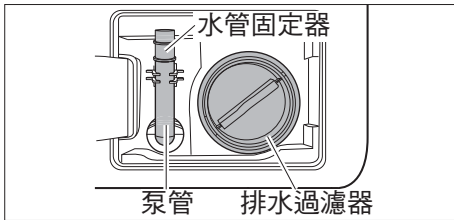

- 3 拉出泵管並移除水管固定器，以將水排入容器內。

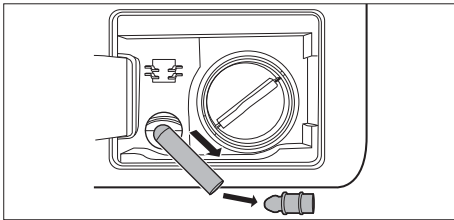

注意

如果洗衣桶內有水（例如洗衣機正在運作），請勿移除排水過濾器。一旦移除，水（很可能是熱水）會傾流而出。

- 4 完成排水後，以逆時針方向扭開排水過濾器並拉出。

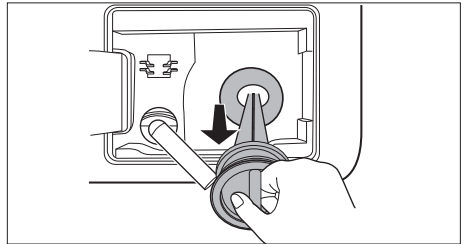
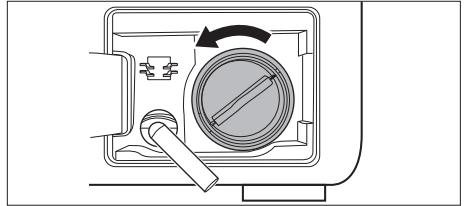



- 5 移除所有線頭及碎屑。
- 6 裝回排水過濾器。
- 7 裝回水管固定器及泵管，然後關上排水過濾器蓋。

注意

請確保以順時針方向將排水過濾器扭回原位。否則可能會導致漏水。

疑難排解

	問題	成因及措施
洗衣機	按鈕失靈	<ul style="list-style-type: none"> - 洗衣機運作期間無法變更設定。惟有暫停運作後，方可變更脫水轉速及「Extra Rinse（額外過水）」設定。 - 可能啟動了Child Lock（兒童安全鎖）（）。（第26頁）
	機門不能打開	<ul style="list-style-type: none"> - 洗衣機運作時機門會鎖上。（第14頁） - 可能啟動了Child Lock（兒童安全鎖）（）。（第26頁） - 洗衣桶內溫度可能太高。 - 水位可能太高。 <p>■ 要立即開門</p> <ol style="list-style-type: none"> （1）關閉洗衣機電源，然後重新開啟。 （2）執行Spin（脫水）程序（第24頁）。完全排水及溫度下降後，即可開門。 <ul style="list-style-type: none"> - 如果機門鎖上時您關閉了洗衣機或電力供應中斷，機門將維持上鎖，直至洗衣機電源開啟。
	異味	<ul style="list-style-type: none"> - 剛開始使用洗衣機時，橡膠部分可能會有異味，但一段時間後便會消散。 - 請執行「Tub Clean（除菌淨桶）」程序以清洗洗衣桶。（第28頁）
洗衣	洗衣機沒有注水	<ul style="list-style-type: none"> - 可能已關上水龍頭。 - 供水管可能已經中斷。 - 供水管可能結冰。（第27頁） - 供水過濾器可能瘀塞。（第27頁）
	洗衣時水量會增加	<ul style="list-style-type: none"> - 這是正常現象。水位下降時洗衣機會自動注水。
	洗衣時會將水排走	<ul style="list-style-type: none"> - 如果泡沫太多，洗衣機可能會排水及注水，以沖走泡沫。這是泡沫偵測功能。 - 即使直接注水至洗衣桶，亦可能直接排走，水量不會增加。

	問題	成因及措施
過水／脫水	過水期間沒有注水	- 過水前，洗衣機會轉動以排走殘留的水，然後重新注水。
	完成脫水前已開始過水	- 如果洗衣機偵測到衣物在洗衣桶內分佈不平衡，會自動開始過水以修正情況。 - 洗衣後如有過多泡沫，可能會排水再注水以沖走泡沫。這是泡沫偵測功能。
	脫水期間，洗衣桶會停下並轉動數次	- 此乃正常現象。如果洗衣機偵測到衣物在洗衣桶內分佈不平衡，會自動嘗試修正情況。 - 衣物可能過輕。 →請嘗試多放入一兩條浴巾。
	門上或機門膠圈留有泡沫或水	- 視乎衣物與洗衣劑用量，可能會留有泡沫及水。取出衣物前，請先抹走泡沫及水。
時間	顯示的剩餘時間有變	- 屏幕顯示時間僅供參考，洗衣機會不斷修正。 - 如果變更過額外過水及脫水設定，或者洗衣機偵測到衣物在洗衣桶內分佈不平衡並作調整，剩餘時間可能會增加。
洗衣劑與泡沫	泡沫不足／太多	- 視乎水溫、水位和水硬度，泡沫量可能不同。 以下情況可能導致泡沫較少 - 洗衣粉可能直接倒入了洗衣桶內。 →應將洗衣粉倒入洗衣劑格內。（第12頁） - 使用了太少洗衣劑。 - 使用了產生泡沫較少的的洗衣劑 - 衣物可能非常骯髒。 - 衣物量可能太多。 以下情況可導致泡沫較多 - 使用了太多洗衣劑。

疑難排解 (續)

	問題	成因及措施
洗衣劑與泡沫	柔順劑滿瀉	- 柔順劑用量可能已經超過洗衣劑格內的「MAX」線。 (第12頁) - 關上洗衣劑格時可能太用力, 柔順劑因而濺出。
	洗衣完成後衣物留有洗衣粉	- 洗衣粉可能直接倒入了洗衣桶內。 → 應將洗衣粉倒入洗衣劑格內。(第12頁)
發出聲音	有不正常的聲音或振動	- 洗衣桶內可能有金屬物件。 - 螺栓可能尚未移除。(第36頁) - 洗衣機可能未置於平穩的表面上。 - 開始清洗時可能放入了濕透衣物。 → 請在清洗前進行脫水或擰乾衣物。
	排水時發出聲音	- 此乃正常現象。水泵運作時會發出聲音。
	有風扇轉動的聲音	- 此乃正常現象。風扇會轉動以冷卻電器零件。
其他	洗衣機運作期間電力供應中斷	- 洗衣機在電源恢復後, 會從中斷階段恢復運作。 (自動重啟)
	洗衣機運作期間斷路器中斷供電	- 請先找出斷路器斷電的原因並解決問題, 然後重設斷路器。 洗衣機在電源恢復後, 會從中斷階段恢復運作。 (自動重啟)
	供水受阻	- 供水恢復時, 水的顏色一段時間內都可能異於平常。 → 請移除供水管並打開水龍頭, 直至排走所有顏色異常的水, 然後重新連接供水管。(第38頁)
	顯示不清晰	- 洗衣機可能置於強烈光線或太陽下。

錯誤顯示

 <p>無法排水</p>	<p>解決方法</p> <p>檢查排水管是否有以下任何問題：</p> <ul style="list-style-type: none">- 排水管瘀塞。- 排水管末端浸於水內。- 排水管升高超過1 m。- 管內的水結冰。 <p>如有瘀塞，請清潔排水過濾器。（第29頁）</p> <p>解決上述問題後，請打開機門再關上，然後按「Start/Pause（開始／暫停）」按鈕重新啟動洗衣機。（然而，機門可能由於水位問題而無法打開。如果發生此情況，請關閉洗衣機電源，然後重新開啟並重覆以上步驟。）</p>
 <p>機門打開</p>	<p>解決方法</p> <p>請確保機門已完全關上。</p> <p>緊關上機門然後按「Start/Pause（開始／暫停）」按鈕。</p>
 <p>無法脫水</p>	<p>洗衣機設計為可偵測衣物分佈不平均的情況（特別是洗衣量較少時）以確保運作過程安靜，且能達到最佳效果。</p> <p>這並非故障。請使用以下任何一個解決方法。</p> <p>解決方法</p> <ul style="list-style-type: none">- 請解開纏在一起的衣物。- 如果衣物由於體積太大（例如毛氈）導致過重，請減少衣物量。- 如果衣物太輕，請加入一兩條浴巾。- 請檢查洗衣機是否置於平穩表面。- 請使用可調地腳，以確保水平放置。 <p>解決上述問題後，請打開機門再關上，然後按「Start/Pause（開始／暫停）」按鈕重新啟動洗衣機。</p>
 <p>無法供水</p>	<p>解決方法</p> <p>檢查是否有以下任何問題：</p> <ul style="list-style-type: none">- 供水水龍頭沒有打開。- 水管結冰。- 供水中斷。- 供水過濾器瘀塞。（第27頁） <p>解決上述問題後，請打開機門再關上，然後按「Start/Pause（開始／暫停）」按鈕重新啟動洗衣機。</p>
	<p>顯示以H開頭的錯誤代碼。</p> <p>解決方法</p> <p>以防萬一，請關上水龍頭。查看「H」字後兩位數字，拔掉洗衣機插頭，並聯絡本公司的服務代理商。</p>

選擇正確的位置

- 請聯絡服務人員安裝。請勿自行安裝。
- 如果未有按照以下方法安裝、測試運作及檢查本洗衣機，Panasonic對由此任何造成的意外或損壞概不負責。

洗衣機尺寸

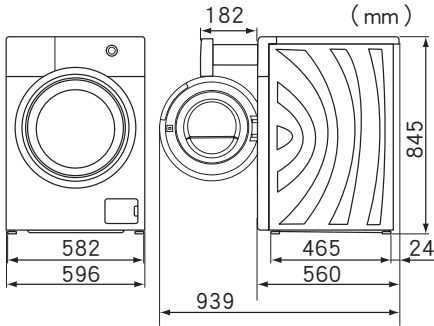

■ 不適合安裝洗衣機的位置

- 在潮濕的地方或室外安裝，可能會讓洗衣機受雨水等外部環境影響（這樣可能導致觸電或起火）
- 不平穩的地面（這樣可能導致振動及發出聲音）
- 陽光直射的地方（這樣可能導致故障及變形）

注意

請勿安裝在溫度可達冰點的地方。

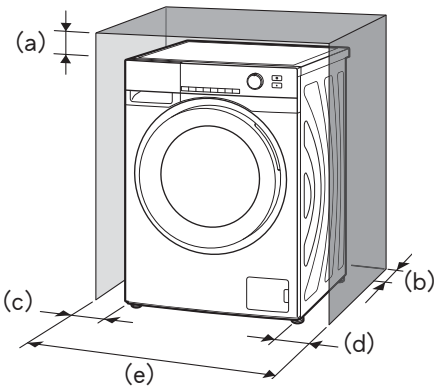

■ 內嵌安裝

- 安裝時請確保能方便使用電源插頭及插座。
- 安裝時請確保四周空間充裕。

- (a)：頂部至少3 mm
- (b)：背面至少5 mm
- (c)：左側至少2 mm
- (d)：右側至少2 mm
- (e)：至少64 cm

注意

請勿讓洗衣機的金屬部分接觸金屬水槽或其他電器。

搬運及安裝

搬運洗衣機

請勿獨自搬運。



請將洗衣機向後傾斜，一人扶住洗衣機底部，另一人扶住頂部後方。

2 將底板後方扣爪扣上洗衣機底部。

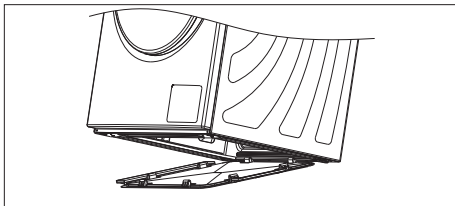

3 將底板後方扣爪扣上洗衣機底部直至聽到「嗒」一聲。

4 將底板左右扣爪確實扣上洗衣機底部直至聽到「嗒」一聲。

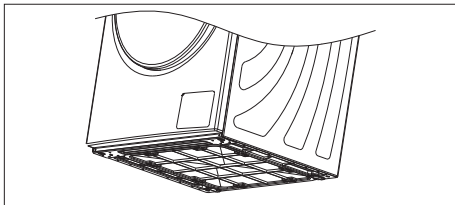

底板安裝

由於底板配件位於包裝的上層泡沫墊內，請勿拋棄。

上層泡沫墊

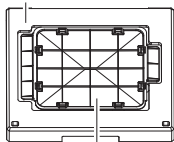

底板

底板安裝時「FRONT」標記必須朝向正面。

1 將洗衣機向後傾斜約60°並穩住，然後將底板安裝在底部。

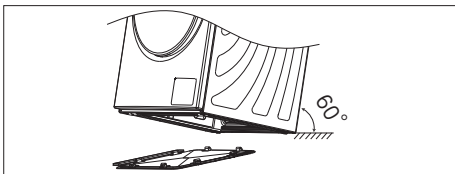

搬運及安裝 (續)

移除螺栓

螺栓固定洗衣機內部，免受運輸期間晃動影響。

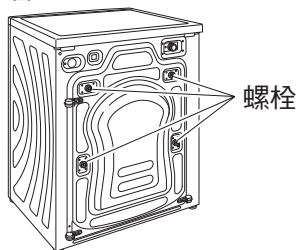

1 使用扳手鬆開4個螺栓（4粒）。

(洗衣機背面)

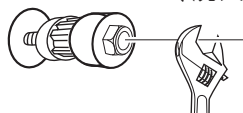

2 逆時針轉動螺栓橡膠部份並拉出。



3 將蓋放在孔上。如果未放上蓋，異物可能會進入洗衣機導致故障。



註

- 如未移除螺栓，洗衣機運作時會劇烈晃動。因此，運作前必先移除螺栓。
- 請妥善保存好取下的螺栓，以後搬運洗衣機時會需要用到。
- 再次搬運洗衣機時，請務必將螺栓裝回洗衣機。按移除時的相反步驟即可重新安裝。

平衡洗衣機

準備一把薄扳手及水平尺。(未隨附)

使用水平尺來確保洗衣機水平放置。

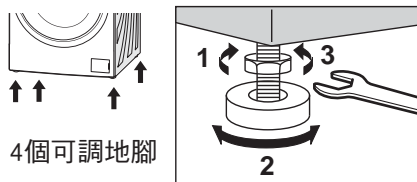
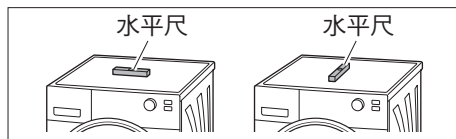

- 1 用扳手鬆開固定螺帽。
- 2 旋轉地腳以調整高度。
- 3 鎖緊固定螺帽。

註

- 確定所有固定螺帽已經完全鎖緊，且可調地腳仍然固定栓緊於洗衣機下方。如果沒有栓緊，洗衣機可能會移動。

連接水管

請正確連接水管以免漏水。

■水管及電線的最長連接距離

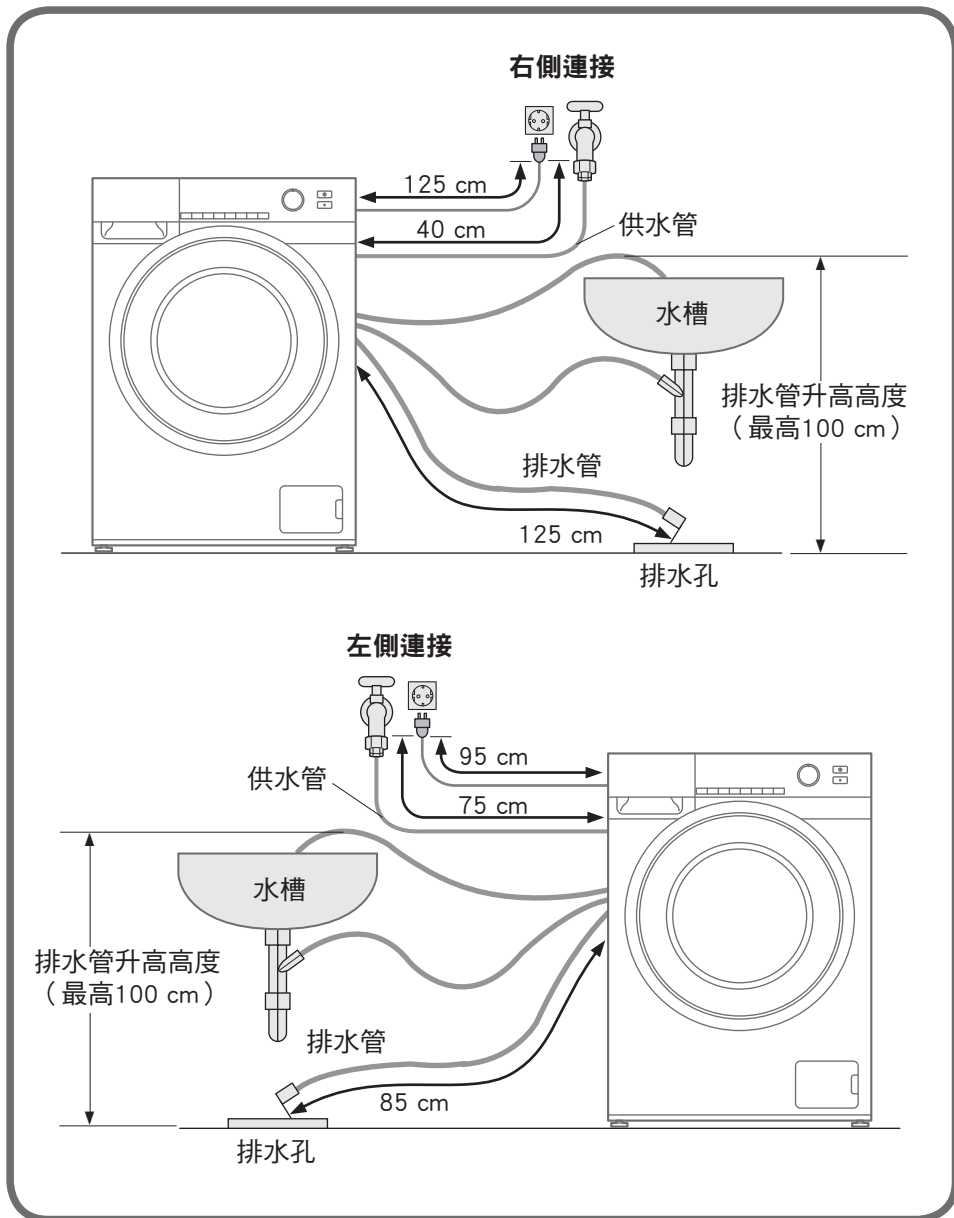

連接水管 (續)

供水管

■主水管水壓及流量

- 水壓：0.03-1 MPa
如果水壓過高，則需要安裝減壓閥。
- 水龍頭流量：至少5 L/min

■連接供水管

注意

- 請勿扭動、擠壓、改裝或剪短水管。
- 請鎖緊螺帽。

- 1 將水管一端連接到洗衣機的入水口，然後用手扭緊。

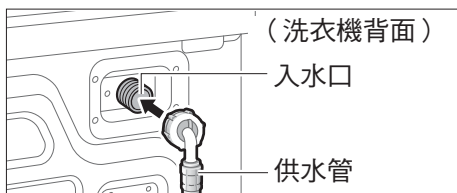

- 2 將水管另一端連接到水龍頭，然後用手扭緊。

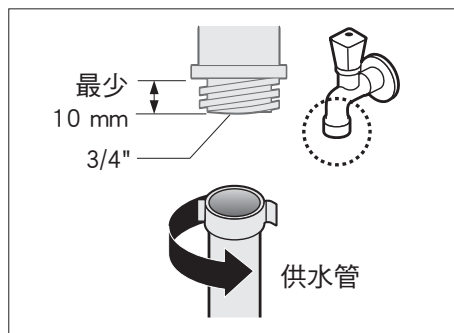

- 3 慢慢打開水龍頭，並確認沒有漏水。

排水管

■排水至水槽或洗手盆

注意

請用水管彎頭固定水管，以免排水水壓沖脫。

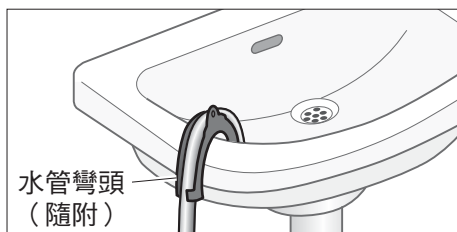

■排水至豎管

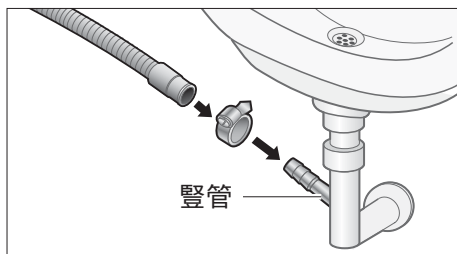

■排水至排水管

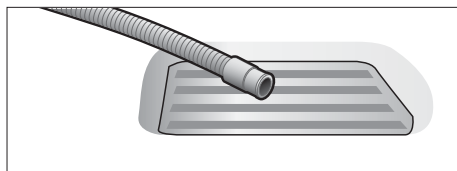

註

- 請勿扭動、拉出或彎曲排水管。
- 請勿將排水管末端浸於水內。

安裝後的檢查

洗衣機零件檢查表

螺栓



- 是否已經移除全部4個螺栓並裝上罩蓋？（第36頁）

電源插頭

- 洗衣機是否插於AC 220 V至240 V的家用插座？

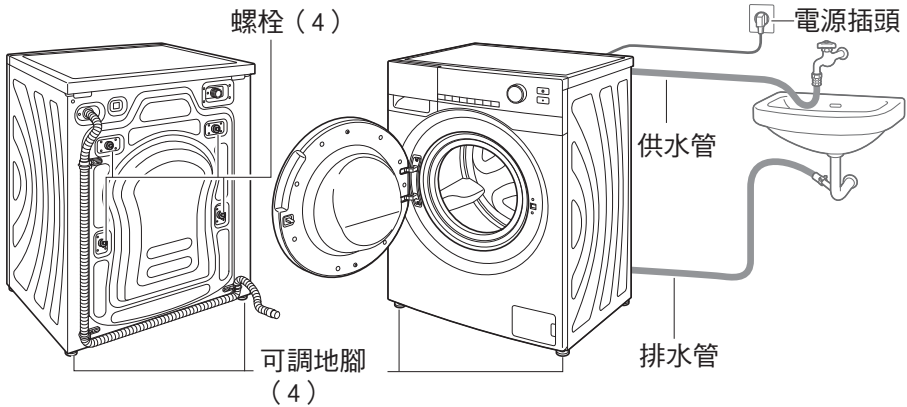

可調地腳

- 是否平穩及鎖緊？（第36頁）
- 洗衣機是否水平放置？（第36頁）

供水管

- 供水管有否正確連接？有否漏水？（第38頁）

安裝位置

- 洗衣機是否置於平穩的表面上？
- 運作時有否晃動？（第36頁）

排水管

- 排水管有否正確連接？有否正常排水？（第38頁）

安裝後的檢查 (續)

運作測試

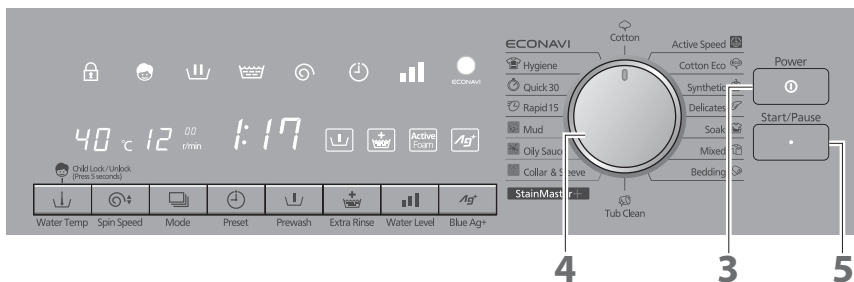

1 打開水龍頭。

2 關上機門，洗衣桶內不放置任何衣物。

3  開啟洗衣機。

4  選擇「Rapid 15 (速洗 15)」程序。

5  開始運作。

漏水

- 請檢查洗衣機和水管接口。(第37頁)

異常聲音

- 確保洗衣機水平放置。(第36頁)

錯誤顯示

 無法排水 (第33頁)

 無法供水 (第33頁)

- 解決問題後，請重新打開再關上洗衣機門，然後按「Start/Pause (開始/暫停)」按鈕以繼續進行測試。

用電量與用水量

程序	水溫	水位	洗衣量	用電量*1	用水量*1	需時*1
 Cotton (棉質)	冷水	高	10 kg	0.15 kWh	95 L	1:02
	40 °C	高	10 kg	1.0 kWh	95 L	1:17
	60 °C	高	10 kg	1.5 kWh	95 L	1:32
 Cotton Eco (棉質 (環保))	60 °C*2	高	10 kg	1.05 kWh	81 L	1:35
ECONAVI (智慧節能)	冷水	高	10 kg	0.4 kWh	94 L	2:23
	40 °C	高	10 kg	1.1 kWh	94 L	2:38

*1 表格內的用電、用水及需時資料可能因以下因素而有異：水壓、水硬度、水溫、室溫、衣物類型、洗衣量、電壓波動、所選的額外功能。

*2 清洗額定容量的一般骯髒衣物，建議使用「Cotton Eco (棉質 (環保))」程序、60 °C水溫及高水位設定。

規格

型號	NA-120VX7
額定電壓	220 - 240 V
額定頻率	50 Hz
最大能量額定輸入功率	1670 - 1990 W
熱能額定輸入功率	1610 W (230 V)
最高脫水轉速	每分鐘1200轉
產品尺寸	596 mm (闊) × 560 mm (深) × 845 mm (高)
產品重量	66 kg
乾衣物最大重量	10 kg
用水量	請參照「用電量與用水量」。 (第41頁)
水龍頭水壓	0.03 - 1 MPa

■ 檢查電源供應

洗衣機的額定功率載於標示牌上。
請確保符合您居住地的規格。

